

DOOR catalogue
edition 1/2012



INVADO®

We open dreams



We open dreams

Nowadays we live in a constant rush trying to find peace, beauty and a safe asylum in our home and the places where we live. The need for safety, quality of life in a beautiful environment has become a common and necessary. People want to protect what they love and surround themselves with beautiful objects.

INVADO LLC, located in Dzielna, is one of the fastest growing manufacturers of doors, door frames, skirtings and finishing profiles, made of MDF and finger-joint pinewood, in Poland. INVADO is also a leading supplier of components for the furniture industry. The Company builds its market position basing on over twenty years of experience and continuous investment in technology, people and quality improvement.

ACTIVITY

INVADO started its activity from production of wooden houses and garden furniture and then (after launching of production line for profiles' wrapping) extended its offer with finishing profiles designed for wall panels and floor panels. Currently INVADO supplies the largest and most well-known furniture manufacturers in Poland and Europe in profiles wrapped into decorative foils and natural veneers. The profiles are used for production of furniture front doors, decorative elements, furniture legs, sides of beds etc. INVADO manufactures a wide range of skirtings for finishing of wooden and laminated floors.

Quality above all

INVADO continually strives to ensure optimal quality of its products, taking into account the individual needs of users. Quality is paramount - this is the basic issue in the design phase and remains the common denominator for all production processes. ISO 9001: 2009 certificate provides such an approach to the issue of quality.

All INVADO products meet European standards. The high level of products and services next to the price and delivery time is the primary objective of the Company, ensuring its perception as a trusted partner.

Certificates and awards



CONSUMER'S LAUREL

INVADO brand has been recognized by Polish consumers and honored with the prestigious Consumer's Laurel emblem.

BUSINESS GAZELLE

INVADO has again been awarded The Business Gazelle - a certificate awarded by the journal "Pulse of Business" for the most dynamically developing companies in Poland.

TRANSPARENT COMPANY

INVADO was awarded by DUN AND BRADSTREET POLAND a „TRANSPARENT COMPANY” Certificate. Receiving this award demonstrates integrity in the discharge of the obligation to timely publication of financial statements and confirms the transparency of activity in the market. The certificate is the same as a reflection of the fact that

INVADO operates according to principles of fair play.



TABLE OF CONTENTS:

CLASSIFICATION OF INVADO FOILS/ VENEERS/ LAMINATES.....	2
INVADO TECHNOLOGY.....	3
COLLECTION OF MODULAR FOILED AND VENEERED DOORS	
Domino.....	NEWS 4
D'Artagnan.....	6
COLLECTION OF MODULAR FOILED DOORS	
Bianco.....	NEW 8
Richelieu.....	NEWS 10
Malawi.....	12
Gwinea.....	14
COLLECTION OF MODULAR VENEERED DOORS	
Aramis.....	16
Atos.....	18
Portos.....	18
COLLECTION OF FOILED DOORS	
Tivoli.....	20
Novara.....	20
Donna.....	20
Passo.....	20
Genoa.....	22
Lido.....	24
Virgo.....	26
Gemini.....	26
Aquarius.....	28
Libra.....	28
Taurus.....	28
Sagittarius.....	28
Torino.....	30
Merano.....	30
Perugia.....	32
Modena.....	32
Verona.....	32
Dolce.....	34
Nida.....	34
Classic.....	NEW 34
Norma Decor.....	NEWS 36
COLLECTION OF GLASS DOORS	
Amber.....	NEWS 38
COLLECTION OF NON-REBATED DOORS	
Plano.....	NEWS 40
Quadro.....	NEWS 40
COLLECTION OF INTERIOR ENTRANCE DOORS	
Egida.....	41
Norma Decor 7.....	41
TECHNICAL DOORS (FIRE DOORS)	
Guardia.....	42
Ignis.....	44
FOLDING DOORS.....	NEWS 45
SLIDING SYSTEMS	
On-wall sliding system.....	46
"POCKET" sliding system (hidden in the wall).....	47
TECHNICAL INFORMATION	
Door dimensions.....	48
Adjustable door frame for non-rebated doors.....	48
Adjustable door frame.....	48
Block door frame.....	49
ACCESSORIES:.....	50
Handles.....	NEWS 52
"PRESTIGE" SKIRTINGS.....	53
GLASS.....	54

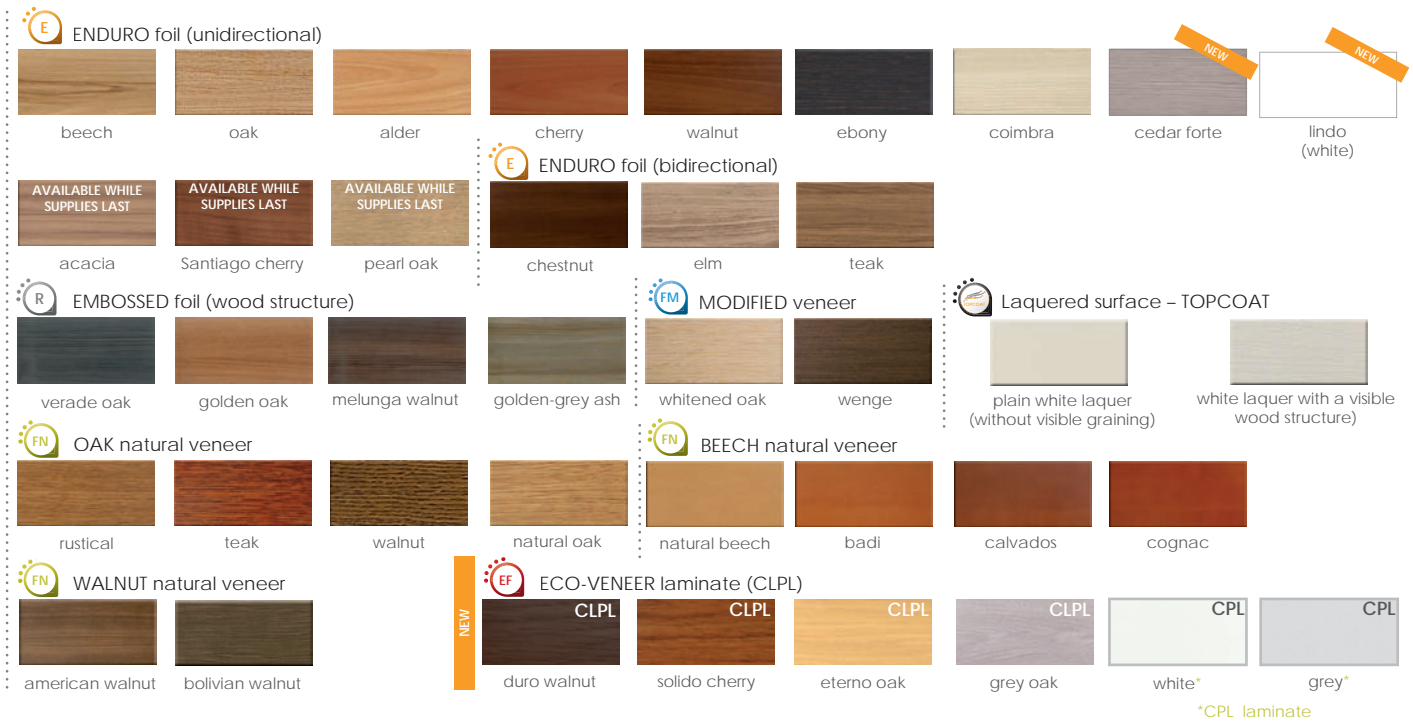

INVADO DECORS' PALETTE:

ENDURO foil

beech, oak, alder, cherry, walnut, oak perlowy, Santiago cherry, coimbra, acacia, ebony, chestnut, elm, teak.
Strength class: ●●●

NATURAL veneer

rustical, natural oak, teak, walnut, natural beech, badi, calvados, cognac, american walnut, bolivian walnut
Strength class: ●●●●

MODIFIED veneer

whitened oak, wenge
Strength class: ●●●●●

Laquered surface - TOPCOAT

plain white laquer (without visible graining), white laquer with a visible wood structure
Strength class: ●●●●●●

EMBOSSSED foil (wood structure)

verade oak, golden oak, melunga walnut, golden-grey ash
Strength class: ●●●●●

ECO-VENEER laminate (CLPL)

duro walnut, solido cherry, eterno oak, grey oak, white*, grey*
Strength class: ●●●●●●●
*CPL laminate

STRENGTH CLASSIFICATION OF INVADO FOILS

intensity of use	classification	intended for :	
●	LOW 1 does not appear in INVADO doors	Buildings and living quarters with a wide range of use	
●●	LOW 2 does not appear in INVADO doors		
●●●	MEDIUM 1 Foil/veneer of high-quality design and very good reproduction of the natural grain. It is characterized by excellent strength characteristics.		
●●●●	MEDIUM 2 Foil/veneer with improved parameters of aesthetic and durability. Natural veneer, because of its origin, is also environmentally friendly material.		
●●●●●	TOP 1 High quality foils/veneers in modern colors, very high strength parameters.		Hotels, offices, public buildings
●●●●●●	TOP 2 Foil/veneer of aesthetic properties as a coating TOP 1, however the highest available strength characteristics.		

Due to the unique character of natural veneer there may occur the differences in shade and structure of veneer. Additionally in case of modified veneer the finger joining of veneer is possible.

INVADO TECHNOLOGY:



Production of door leaves and door frames is the strongest point of INVADO offer, therefore a major breakthrough in the Company's activity was the implementation of innovative production technology of foiled doors (INVADO Technology). Now thanks to the innovative method of doors' production, INVADO is among the most technologically advanced companies in Europe. A characteristic feature of this technology is foiling of surfaces without connecting of foil on rebate edges. Due to this method the edge looks aesthetically and is also more resistant to damage. In principle there is no possibility of breaking off the foil, because the connection of foil is placed the inner edge of the rebate - invisible to the eye. Patent No. 204 829 protecting the invention called „Technology of foiling flat doors in the mass production system“ is used since 2007 in case of all foiled doors. In addition – off-rebate foiling makes the INVADO doors as the only ones on the market have rounded edges, safe for adults and children hands.

Safe edges..

INVADO foiled doors are manufactured basing on INVADO patented technology, which consists on connecting of the foil out of the rebate edge. Door edges, made in this unique technology, are protected against abrasion and breaking off the foil and stay beautiful and new for a longer period of time.



COLLECTION OF INVADO DOORS:

Collection of INVADO doors is the result of combination of a unique, patented technology and years of experience of INVADO experts. INVADO doors are appropriate both in traditional and modern interiors, in public buildings and private homes. Every year INVADO collection is enriched with new models and decors to create new opportunities for interior design. INVADO doors have a simple, clear and recognizable style, which is characterized by the attention to details, quality and precision of construction.



Domino



AVAILABLE DECORS:



AVAILABLE GLASSES:



Modular Domino doors in veneered version are equipped with - depending on the model - laminated glass 2 + 2 or 3 + 3 [mm], in which both sides are glossy (smooth), and the modular doors Domino in foiled version are equipped with uniform glass, in which one party is matt (rough). **NOTE: in case of modular doors the glossy side of glass is on the hinges side.**

CONSTRUCTION OF MODULAR FOILED AND VENEERED DOORS DOMINO:

- frame is made of finger joint pinewood, covered with MDF and HDF boards, wrapped into veneer,
 - the frame of foiled doors is made of high quality MDF, wrapped into decorative foil (ENDURO, embossed or ECO-VENEER),
 - in case of foiled door leaves there are strips connecting the individual elements of filling,
 - Door leaf can be shortened by max 40 mm (not applicable to door leaves with ventilation),
 - width of single doors - from „60“ to „100“*,
 - width of double doors - from „120“ to „200“**.
- * veneered version - from "60" to "90" **veneered version - from "120" to "180"

STANDARD EQUIPMENT:

- lock 72 mm for standard key, WC knob or cylinder lock insert,
- screw-in pivot hinges, regulation 3D (white zinc) - 2 pcs in door leaves "60" - "80", 3 pcs in door leaves "90" and "100",
- invisible hinges, regulation 3D, INOX color,*
- door leaf is filled with 4 mm or 6 mm-thick glasses and/or 10mm-thick MDF boards,
- caps for screw-in pivot hinges with regulation 3D (brass or chrome).

Technical Approval ITB AT-15-7089/2011

* available in non-rebated version only

ACCESSORIES AVAILABLE AT EXTRA CHARGE:

- ventilation undercut
- door without a key hole
- door width „100“
- metal ventilation sleeves, round (chrome, brass)
- metal ventilation sleeves, square (chrome, nickel)
- door made in non-rebated version (veneered only)
- non-rebated door for sliding system
- double door
- cylinder lock insert 31/36

Additional information on the equipment and accessories can be found at the page 50 - 51

AVAILABLE DOOR FRAMES:



BLOCK DOOR FRAME:

This is a door frame, which traditional simple design has been adapted to the typical thickness of the wall. With finishing trims, aesthetic performance and a wide range of decorative foils and natural veneers, it is a modern element of any interior equipment.



ADJUSTABLE DOOR FRAME:

This is a box type frame, which advantages are the possibility to cover each thickness of the wall and additional regulation. With modern design, aesthetic performance and a wide range natural veneers and decorative foils, it is a modern element of any interior equipment.



ADJUSTABLE DOOR FRAME FOR NON-REBATED DOORS:

The door frame is designed for non-rebated doors. Architraves in the door frame are joined at right angle. Available in veneered version only.

Detailed information on door frames can be found at the page 48 - 49

D' Artagnan



D' Artagnan 1

D' Artagnan 1



D' Artagnan INTERO

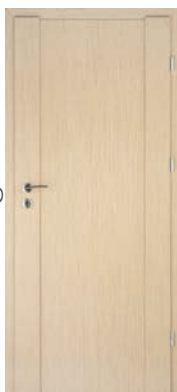

D' Artagnan SOLEI



D' Artagnan PLUS



D' Artagnan RIGA



D' Artagnan TONDO



AVAILABLE DECORS:

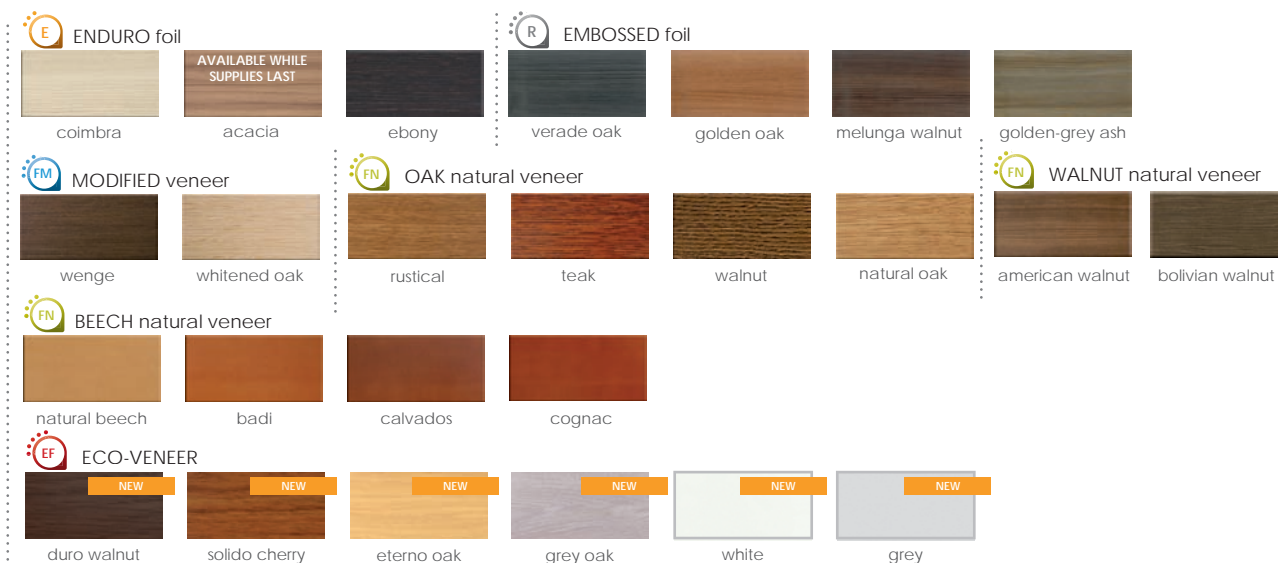

AVAILABLE GLASSES:



NOTE: the matt (engraved) side of glass is located on the hinges side

CONSTRUCTION OF MODULAR FOILED AND VENEERED DOORS D'ARTAGNAN:

- frame is made of finger joint pinewood, covered with MDF and HDF boards, wrapped into decorative foil (ENDURO, embossed or ECO-Veneer) or natural/modified veneer,
 - width of single doors - from „60” to „100”*,
 - width of double doors – from „120” to „200”**.
- * veneered version - from “60” to “90” **veneered version - from “120” to “180”

STANDARD EQUIPMENT

- lock 72 mm for standard key, WC knob or cylinder lock insert,
- screw-in pivot hinges, regulation 3D (white zinc) – 2 pcs in door leaves “60” – “80”, 3 pcs in door leaves “90” and “100”,
- door leaf is filled with 10mm-thick MDF boards or 6 mm-thick glass ,
- caps for screw-in pivot hinges with regulation 3D (brass or chrome).

Technical Approval ITB AT-15-7089/2011

Additional information on the equipment and accessories can be found at the page 50 - 51

ACCESSORIES AVAILABLE AT EXTRA CHARGE :

- ventilation undercut
 - door without a key hole
 - door width „100”
 - metal ventilation sleeves, round (chrome, brass)*
 - metal ventilation sleeves, square (chrome, nickel)*
 - door made in non-rebated version (veneered only)
 - non-rebated door for sliding system
 - double door
 - cylinder lock insert 31/36
- * available in D' Artagnan INTERO.

AVAILABLE DOOR FRAMES:



BLOCK DOOR FRAME:

This is a door frame, which traditional simple design has been adapted to the typical thickness of the wall. With finishing trims, aesthetic performance and a wide range of decorative foils and natural veneers, it is a modern element of any interior equipment.

ADJUSTABLE DOOR FRAME:

This is a box type frame, which advantages are the possibility to cover each thickness of the wall and additional regulation. With modern design, aesthetic performance and a wide range natural veneers and decorative foils, it is a modern element of any interior equipment.

ADJUSTABLE DOOR FRAME FOR NON-REBATED DOORS:

The door frame is designed for non-rebated doors. Architraves in the door frame are joined at right angle. Available in veneered version only.

Detailed information on door frames can be found at the page 48 - 49

Bianco

NEW

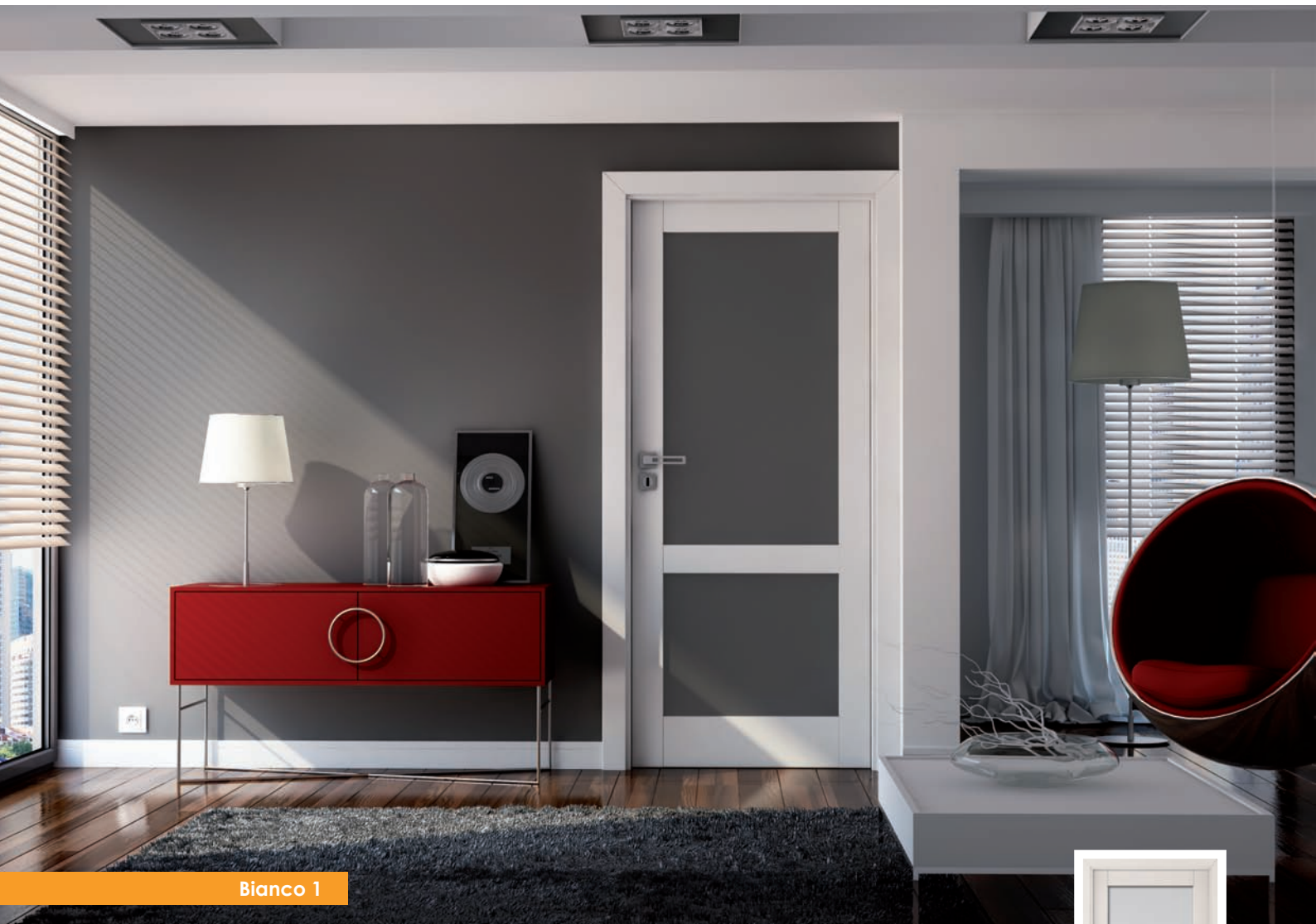

Bianco 1

Bianco 1



Bianco 2



Bianco 3



Bianco 4



Bianco 5



Bianco 6

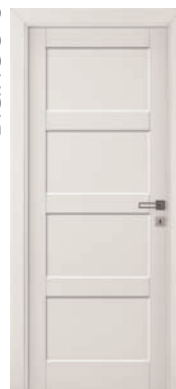

Bianco 7



AVAILABLE DECORS:

ECO-VENEER

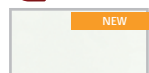

white

AVAILABLE GLASSES:



satinato

NOTE: in case of modular foiled doors the glossy side of glass is on the hinges side..

CONSTRUCTION OF MODULAR FOILED DOORS BIANCO:

- the frame of foiled doors is made of high quality MDF, wrapped into decorative foil (ECO-VENEER),
- Door leaf can be shortened by max 40 mm (not applicable to door leaves with ventilation),
- width of single doors - from „60“ to „100“,
- width of double doors – from „120“ to „200“.

STANDARD EQUIPMENT:

- lock 72 mm for standard key, WC knob or cylinder lock insert,
- screw-in pivot hinges, regulation 3D (white zinc) – 2 pcs in door leaves “60” – “80”, 3 pcs in door leaves “90” and “100”,
- door leaf is filled with 10mm-thick MDF boards and/or 4 mm-thick glass,
- caps for screw-in pivot hinges with regulation 3D (brass or chrome).

ACCESSORIES AVAILABLE AT EXTRA CHARGE:

- ventilation undercut
- door without a key hole
- door width „100“
- metal ventilation sleeves, round (chrome, brass)
- metal ventilation sleeves, square (chrome, nickel)
- non-rebated door for sliding system
- double door
- cylinder lock insert 31/36

Technical Approval ITB AT-15-7089/2011

Additional information on the equipment and accessories can be found at the page **50 - 51**

AVAILABLE DOOR FRAMES:



BLOCK DOOR FRAME:

This is a door frame, which traditional simple design has been adapted to the typical thickness of the wall. With finishing trims, aesthetic performance and a wide range of decorative foils and natural veneers, it is a modern element of any interior equipment.



ADJUSTABLE DOOR FRAME:

This is a box type frame, which advantages are the possibility to cover each thickness of the wall and additional regulation. With modern design, aesthetic performance and a wide range natural veneers and decorative foils, it is a modern element of any interior equipment.

Detailed information on door frames can be found at the page **48 - 49**

Richelieu



Richelieu 1



Richelieu 1
+szyba fiore



Richelieu 2
+szyba fiore

Richelieu 1



Richelieu 2

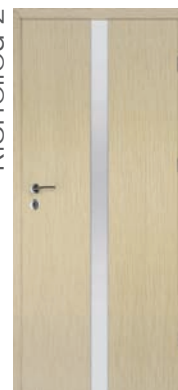

AVAILABLE DECORS:

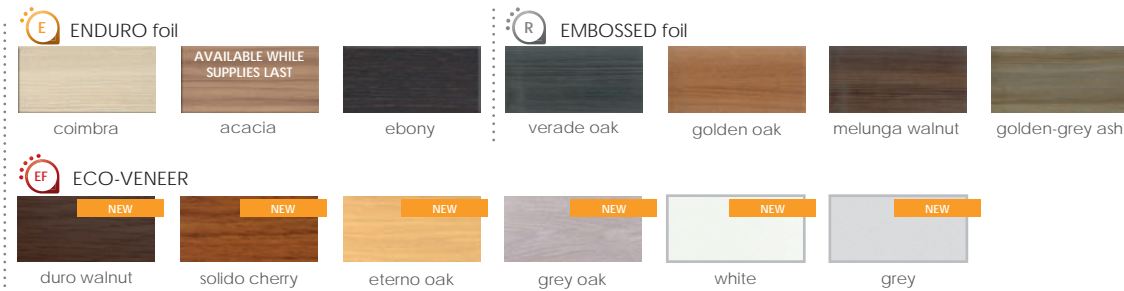

AVAILABLE GLASSES:

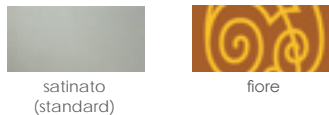

GLASS AVAILABLE AT EXTRA CHARGE:

fiore

NOTE: the matt (printed) side of glass is located on the hinges side.

CONSTRUCTION OF MODULAR FOILED DOORS RICHELIEU:

- frame is made of high quality finger joint pinewood, covered with HDF board and/or with chipboard filling, wrapped into decorative foil (ENDURO, embossed or ECO-Veneer),
- width of single doors - from „60” to „100”,
- width of double doors – from „120” to „200”.

STANDARD EQUIPMENT:

- lock 72 mm for standard key, WC knob or cylinder lock insert,
- screw-in pivot hinges, regulation 3D (white zinc) – 2 pcs in door leaves “60” – “80”, 3 pcs in door leaves “90” and “100”,
- caps for screw-in pivot hinges with regulation 3D (brass or chrome),
- door leaf is filled with 6 mm-thick glass.

ACCESSORIES AVAILABLE AT EXTRA CHARGE :

- door without a key hole
- door width „100”
- metal ventilation sleeves, round (chrome, brass)
- metal ventilation sleeves, square (chrome, nickel)
- non-rebated door for sliding system
- double door
- cylinder lock insert 31/36

Technical Approval ITB AT-15-7089/2011

Additional information on the equipment and accessories can be found at the page **50 - 51**

AVAILABLE DOOR FRAMES:



BLOCK DOOR FRAME:

This is a door frame, which traditional simple design has been adapted to the typical thickness of the wall. With finishing trims, aesthetic performance and a wide range of decorative foils and natural veneers, it is a modern element of any interior equipment.



ADJUSTABLE DOOR FRAME:

This is a box type frame, which advantages are the possibility to cover each thickness of the wall and additional regulation. With modern design, aesthetic performance and a wide range natural veneers and decorative foils, it is a modern element of any interior equipment.

Detailed information on door frames can be found at the page **48 - 49**

Malawi

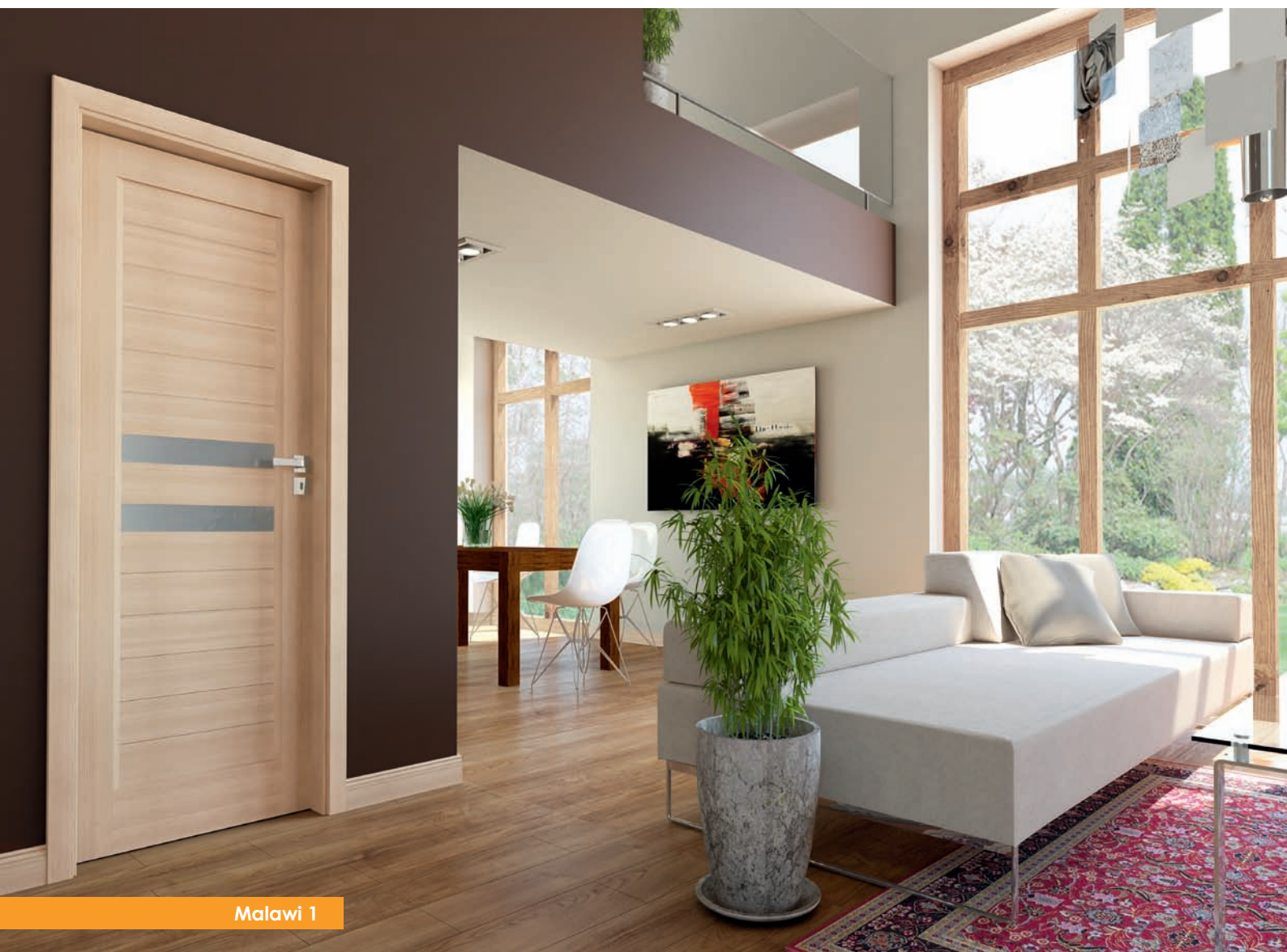

Malawi 1

Malawi 1



Malawi 2



Malawi 3



Malawi 4



Malawi 5



Malawi 6



AVAILABLE DECORS:

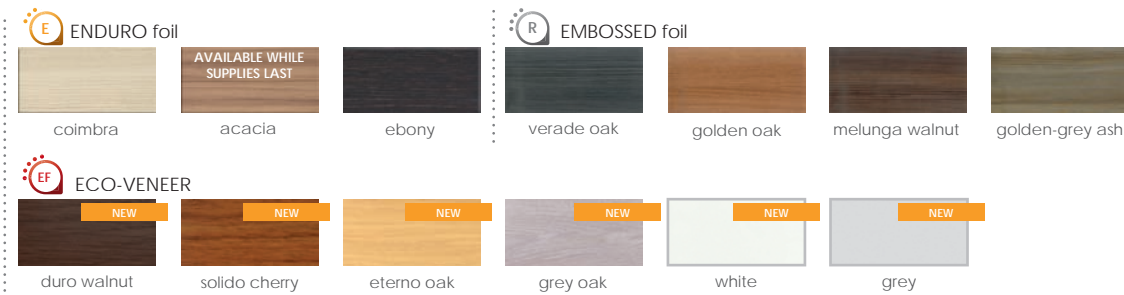

AVAILABLE GLASSES:



NOTE: the glossy side of glass is on the hinges side.

CONSTRUCTION OF MODULAR FOILED DOORS MALAWI:

- the frame of foiled doors is made of high quality MDF, wrapped into decorative foil (ENDURO, EMBOSSSED OR ECO-VENEER)
- Door leaf can be shortened by max 40 mm (not applicable to door leaves with ventilation),
- width of single doors - from „60” to „100”,
- width of double doors - from „120” to „200”.

STANDARD EQUIPMENT:

- lock 72 mm for standard key, WC knob or cylinder lock insert,
- screw-in pivot hinges, regulation 3D (white zinc) – 2 pcs in door leaves “60” – “80”, 3 pcs in door leaves “90” and “100”,
- caps for screw-in pivot hinges with regulation 3D (brass or chrome),
- door leaf is filled with 10mm-thick MDF boards and/or 4 mm-thick glass,

Technical Approval ITB AT-15-7089/2011

ACCESSORIES AVAILABLE AT EXTRA CHARGE :

ventilation undercut

door without a key hole

door width „100”

metal ventilation sleeves, round (chrome, brass)*

metal ventilation sleeves, square (chrome, nickel)*

door made in non-rebated version (veneered only)

non-rebated door for sliding system

double door

cylinder lock insert 31/36

Additional information on the equipment and accessories can be found at the page **50 - 51**

AVAILABLE DOOR FRAMES:



BLOCK DOOR FRAME:

This is a door frame, which traditional simple design has been adapted to the typical thickness of the wall. With finishing trims, aesthetic performance and a wide range of decorative foils and natural veneers, it is a modern element of any interior equipment.



ADJUSTABLE DOOR FRAME:

This is a box type frame, which advantages are the possibility to cover each thickness of the wall and additional regulation. With modern design, aesthetic performance and a wide range natural veneers and decorative foils, it is a modern element of any interior equipment.

Detailed information on door frames can be found at the page **48 - 49**

Gwinea



Gwinea 5

Gwinea 1



Gwinea 2



Gwinea 3



Gwinea 4



Gwinea 5



Gwinea 6



Gwinea 7



AVAILABLE DECORS:

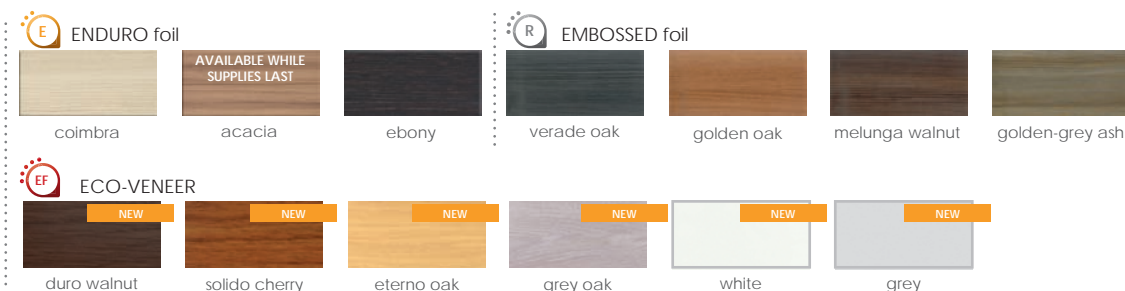

AVAILABLE GLASSES:



satinato (standard)

NOTE: the glossy side of glass is on the hinges side.

CONSTRUCTION OF MODULAR FOILED DOORS GWINEA:

- the frame of foiled doors is made of high quality MDF, wrapped into decorative foil (ENDURO, EMBOSSSED or ECO-VENEER),
- in case of foiled door leaves there are strips connecting the individual elements of filling
- Door leaf can be shortened by max 40 mm (not applicable to door leaves with ventilation),
- width of single doors - from „60” to „100”,
- width of double doors – from „120” to „200”.

STANDARD EQUIPMENT:

- lock 72 mm for standard key, WC knob or cylinder lock insert,
- screw-in pivot hinges, regulation 3D (white zinc) – 2 pcs in door leaves “60” – “80”, 3 pcs in door leaves “90” and “100”,
- caps for screw-in pivot hinges with regulation 3D (brass or chrome),
- door leaf is filled with 4 mm-thick glasses and/or 10mm-thick MDF boards.

Technical Approval ITB AT-15-7089/2011

Additional information on the equipment and accessories can be found at the page **50 - 51**

ACCESSORIES AVAILABLE AT EXTRA CHARGE :

- ventilation undercut
- door without a key hole
- door width „100”
- metal ventilation sleeves, round (chrome, brass)*
- metal ventilation sleeves, square (chrome, nickel)*
- door made in non-rebated version (veneered only)
- non-rebated door for sliding system
- double door
- cylinder lock insert 31/36

AVAILABLE DOOR FRAMES:



BLOCK DOOR FRAME:

This is a door frame, which traditional simple design has been adapted to the typical thickness of the wall. With finishing trims, aesthetic performance and a wide range of decorative foils and natural veneers, it is a modern element of any interior equipment.



ADJUSTABLE DOOR FRAME:

This is a box type frame, which advantages are the possibility to cover each thickness of the wall and additional regulation. With modern design, aesthetic performance and a wide range natural veneers and decorative foils, it is a modern element of any interior equipment.

Detailed information on door frames can be found at the page **48 - 49**

Aramis



Aramis 1

Aramis 1



Aramis 2



Aramis 3



Aramis 4



Aramis 5



AVAILABLE DECORS:

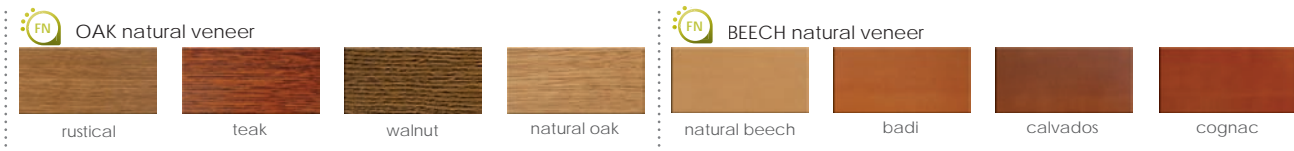

AVAILABLE GLASSES:

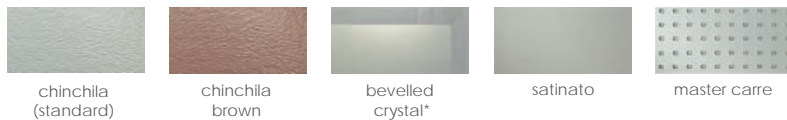

NOTE: the glossy side of glass is on the hinges side

* bevelled crystal is available in 3 versions: transparent, matt and smoked

GLASS AVAILABLE AT EXTRA CHARGE:

master carre

chinchila brown

satinato

bevelled crystal

CONSTRUCTION OF MODULAR VENEERED DOORS ARAMIS:

- frame is made of finger joint pinewood, covered with MDF and HDF boards, wrapped into veneer,
- door leaf can be shortened by max 40 mm (not applicable to door leaves with ventilation),
- width of single doors - from „60” do „90”,
- width of double doors - from „120” do „180”.



STANDARD EQUIPMENT:

- lock 72 mm for standard key, WC knob or cylinder lock insert,
- screw-in pivot hinges, regulation 3D (white zinc) – 2 pcs in door leaves “60” – “80”, 3 pcs in door leaves “90” and “100”,
- caps for screw-in pivot hinges with regulation 3D (brass or chrome),
- door leaf is filled with 18 mm-thick MDF boards wrapped into veneer and/or 4 mm-thick glass.

ACCESSORIES AVAILABLE AT EXTRA CHARGE:

- ventilation undercut
- door without a key hole
- metal ventilation sleeves, round (chrome, brass)*
- metal ventilation sleeves, square (chrome, nickel)*
- non-rebated door for sliding system
- double door
- cylinder lock insert 31/36

Technical Approval ITB AT-15-7089/2011

Additional information on the equipment and accessories can be found at the page **50 - 51**

AVAILABLE DOOR FRAMES:



BLOCK DOOR FRAME:

This is a door frame, which traditional simple design has been adapted to the typical thickness of the wall. With finishing trims, aesthetic performance and a wide range of decorative foils and natural veneers, it is a modern element of any interior equipment.



ADJUSTABLE DOOR FRAME:

This is a box type frame, which advantages are the possibility to cover each thickness of the wall and additional regulation. With modern design, aesthetic performance and a wide range of natural veneers and decorative foils, it is a modern element of any interior equipment.

Detailed information on door frames can be found at the page **48 - 49**

Atos · Portos



Portos 3

Atos 1



Atos 2



Atos 3



Portos 1



Portos 2



Portos 3



AVAILABLE DECORS:



AVAILABLE GLASSES:

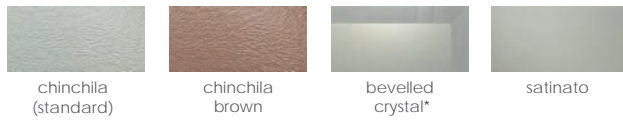

NOTE: the matt side of glass is located on the hinges side.

*bevelled crystal is available in 3 versions: transparent, matt and smoked

GLASS AVAILABLE AT EXTRA CHARGE:

satinato

chinchila brown

bevelled crystal

CONSTRUCTION OF MODULAR VENEERED DOORS ATOS AND PORTOS:

- frame is made of finger joint pinewood, covered with MDF and HDF boards, wrapped into veneer,
- door leaf can be shortened by max 40 mm (not applicable to door leaves with ventilation),
- width of single doors - from „60” do „90”,
- width of double doors – from „120” do „180”.



STANDARD EQUIPMENT:

- lock 72 mm for standard key, WC knob or cylinder lock insert,
- screw-in pivot hinges, regulation 3D (white zinc) – 2 pcs in door leaves “60” – “80”, 3 pcs in door leaves “90” and “100”,
- caps for screw-in pivot hinges with regulation 3D (brass or chrome),
- door leaf is filled with 18 mm-thick MDF boards wrapped into veneer and/or 4 mm-thick glass.

ACCESSORIES AVAILABLE AT EXTRA CHARGE:

- ventilation undercut
- door without a key hole
- metal ventilation sleeves, round (chrome, brass)*
- metal ventilation sleeves, square (chrome, nickel)*
- non-rebated door for sliding system
- double door
- cylinder lock insert 31/36

Technical Approval ITB AT-15-7089/2011

Additional information on the equipment and accessories can be found at the page **50 - 51**

AVAILABLE DOOR FRAMES:



BLOCK DOOR FRAME:

This is a door frame, which traditional simple design has been adapted to the typical thickness of the wall. With finishing trims, aesthetic performance and a wide range of decorative foils and natural veneers, it is a modern element of any interior equipment.



ADJUSTABLE DOOR FRAME:

This is a box type frame, which advantages are the possibility to cover each thickness of the wall and additional regulation. With modern design, aesthetic performance and a wide range of natural veneers and decorative foils, it is a modern element of any interior equipment.

Detailed information on door frames can be found at the page **48 - 49**

Tivoli · Novara · Donna · Passo



CONSTRUCTION OF TIVOLI



CONSTRUCTION OF NOVARA

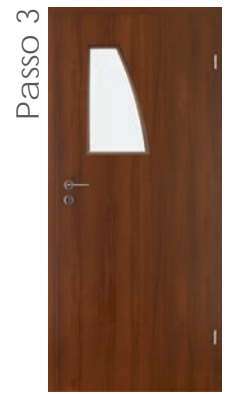
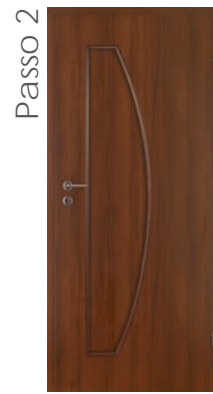
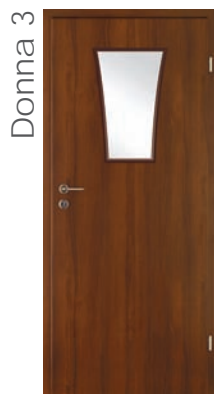
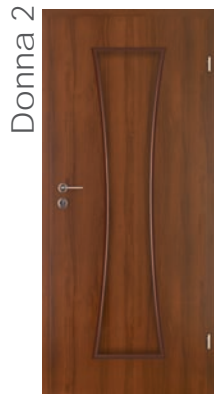
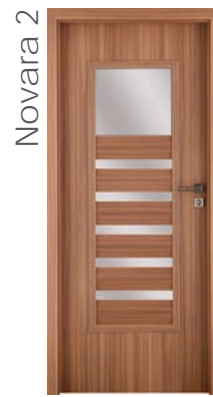

AVAILABLE DECORS:

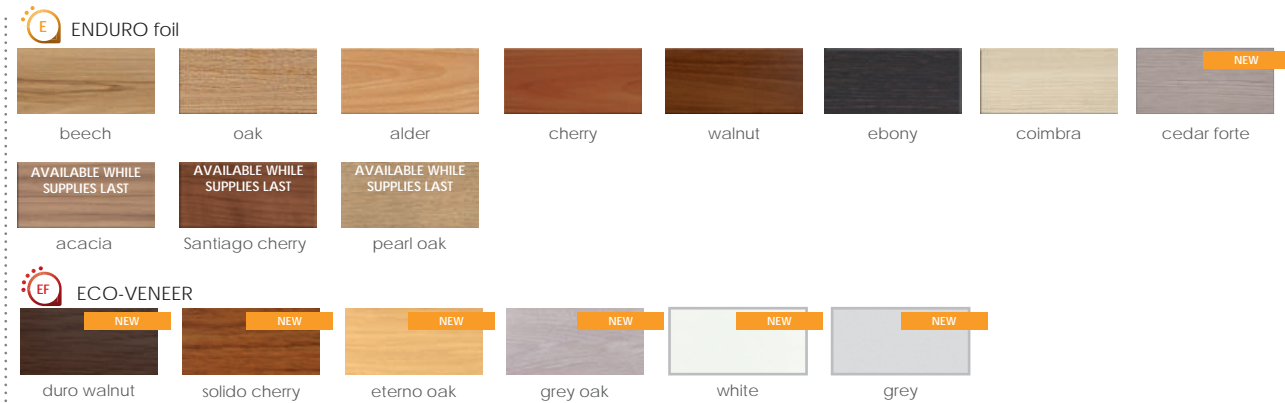

AVAILABLE GLASSES:



satinato
(standard)

NOTE: the glossy side of glass is on the hinges side.

CONSTRUCTION OF FOILED DOORS TIVOLI, NOVARA, DONNA AND PASSO:

- frame is made of MDF board,
- filling – „honey comb” or chipboard (optionally),
- frame with filling is covered with HDF boards on both sides,
- door leaf is wrapped into decorative foil (ENDURO/ECO-VENEER),
- frame for glass is in the door leaf color,
- side edges and upper edge are foiled,
- rounded side edges and upper edge,
- door leaf can be shortened by max 50 mm (not applicable to door leaves with ventilation),
- width of single doors - from „60” to „110”,
- width of double doors – from „120” to „200”.

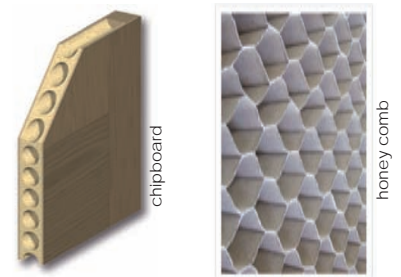

STANDARD EQUIPMENT:

- lock 72 mm for standard key, WC knob or cylinder lock insert,
- screw-in pivot hinges – 2 pcs (3 pcs in door leaves “90” and “110”), white zinc.

Technical Approval ITB AT-15-6702/2005

Additional information on the equipment and accessories can be found at the page **50 - 51**

ACCESSORIES AVAILABLE AT EXTRA CHARGE:

- chipboard filling
- ventilation undercut
- additional hinge in door widths from “60” to “80”
- non-rebated door for sliding system
- double door
- PVC ventilation sleeves
- cylinder lock insert 31/36
- door without a key hole
- door width „100”, „110”
- caps for hinges

AVAILABLE DOOR FRAMES:



BLOCK DOOR FRAME:

This is a door frame, which traditional simple design has been adapted to the typical thickness of the wall. With finishing trims, aesthetic performance and a wide range of decorative foils and natural veneers, it is a modern element of any interior equipment.



ADJUSTABLE DOOR FRAME:

This is a box type frame, which advantages are the possibility to cover each thickness of the wall and additional regulation. With modern design, aesthetic performance and a wide range natural veneers and decorative foils, it is a modern element of any interior equipment.

Detailed information on door frames can be found at the page **48 - 49**

Genua



Genua 3

Genua 1



Genua 2



Genua 3



AVAILABLE DECORS:

E ENDURO foil

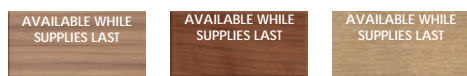

EF ECO-VENEER

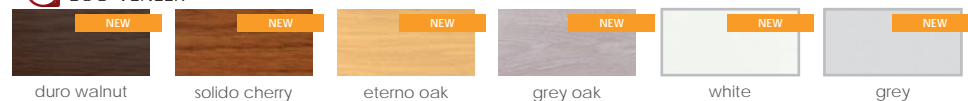

AVAILABLE GLASSES:

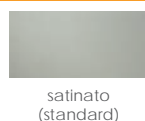

NOTE: the glossy side of glass is on the hinges side.

CONSTRUCTION OF FOILED DOORS GENUA:

- frame is made of MDF board,
- filling – „honey comb” or chipboard (optionally),
- frame with filling is covered with HDF boards on both sides,
- door leaf is wrapped into decorative foil (ENDURO/ECO-VENEER),
- frame for glass is in the door leaf color,
- side edges and upper edge are foiled,
- rounded side edges and upper edge,
- door leaf can be shortened by max 50 mm (not applicable to door leaves with ventilation),
- width of single doors - from „60” to „110”,
- width of double doors – from „120” to „200”.

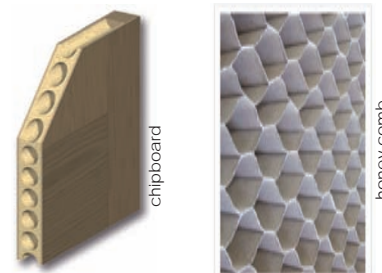

STANDARD EQUIPMENT:

- lock 72 mm for standard key, WC knob or cylinder lock insert,
- screw-in pivot hinges – 2 pcs (3 pcs in door leaves “90” and “110”), white zinc.

Technical Approval ITB AT-15-6702/2005

Additional information on the equipment and accessories can be found at the page **50 - 51**

ACCESSORIES AVAILABLE AT EXTRA CHARGE:

- chipboard filling
- ventilation undercut
- additional hinge in door widths from “60” to “80”
- non-rebated door for sliding system
- double door
- PVC ventilation sleeves
- cylinder lock insert 31/36
- door without a key hole
- door width „100”, „110”
- caps for hinges

AVAILABLE DOOR FRAMES:



BLOCK DOOR FRAME:

This is a door frame, which traditional simple design has been adapted to the typical thickness of the wall. With finishing trims, aesthetic performance and a wide range of decorative foils and natural veneers, it is a modern element of any interior equipment.



ADJUSTABLE DOOR FRAME:

This is a box type frame, which advantages are the possibility to cover each thickness of the wall and additional regulation. With modern design, aesthetic performance and a wide range natural veneers and decorative foils, it is a modern element of any interior equipment.

Detailed information on door frames can be found at the page **48 - 49**

Lido



Lido 3

Lido 1



Lido 2



Lido 3

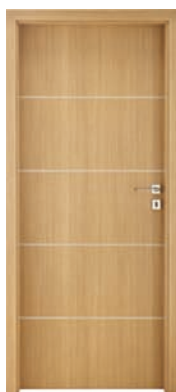

Lido 4



NEW

Lido 5



NEW

AVAILABLE DECORS:

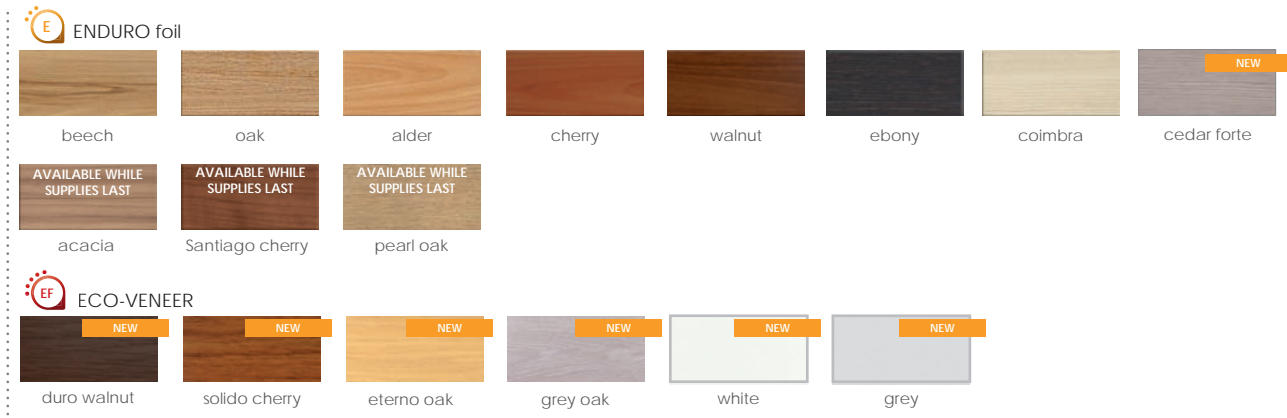

CONSTRUCTION OF FOILED DOORS LIDO:

- frame is made of MDF board,
- chipboard filling,
- width of ALU strip - 8 mm,
- frame with filling is covered with HDF boards on both sides,
- door leaf is wrapped into decorative foil (ENDURO/ECO-VENEER),
- side edges and upper edge are foiled,
- rounded side edges and upper edge,
- door leaf can be shortened by max 50 mm (not applicable to door leaves with ventilation),
- width of single doors - from „60” to „110”,
- width of double doors – from „120” to „200”.



STANDARD EQUIPMENT:

- lock 72 mm for standard key, WC knob or cylinder lock insert,
- screw-in pivot hinges – 2 pcs (3 pcs in door leaves “90” and “110”), white zinc

Technical Approval ITB AT-15-6702/2005

Additional information on the equipment and accessories can be found at the page **50 - 51**

ACCESSORIES AVAILABLE AT EXTRA CHARGE:

- ventilation undercut
- additional hinge in door widths from “60” to “80”
- non-rebated door for sliding system
- double door
- PVC ventilation sleeves
- cylinder lock insert 31/36
- door without a key hole
- door width „100”, „110”
- caps for hinges

AVAILABLE DOOR FRAMES:



BLOCK DOOR FRAME:

This is a door frame, which traditional simple design has been adapted to the typical thickness of the wall. With finishing trims, aesthetic performance and a wide range of decorative foils and natural veneers, it is a modern element of any interior equipment.



ADJUSTABLE DOOR FRAME:

This is a box type frame, which advantages are the possibility to cover each thickness of the wall and additional regulation. With modern design, aesthetic performance and a wide range natural veneers and decorative foils, it is a modern element of any interior equipment.

Detailed information on door frames can be found at the page **48 - 49**

Virgo · Gemini



Virgo 1



AVAILABLE DECORS:



AVAILABLE GLASSES:

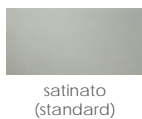

NOTE: the glossy side of glass is on the hinges side.

CONSTRUCTION OF FOILED DOORS VIRGO AND GEMINI:

- frame is made of MDF board,
- filling – „honey comb” or chipboard (optionally),
- frame with filling is covered with HDF boards on both sides,
- door leaf is wrapped into decorative foil (ENDURO/ECO-VENEER),
- frame for glass is in the door leaf color,
- side edges and upper edge are foiled,
- rounded side edges and upper edge,
- door leaf can be shortened by max 50 mm (not applicable to door leaves with ventilation),
- width of single doors – „60”, „70”, „80”, „90”, „100”*, „110”*,
- width of double doors – from „120” to „200”*.

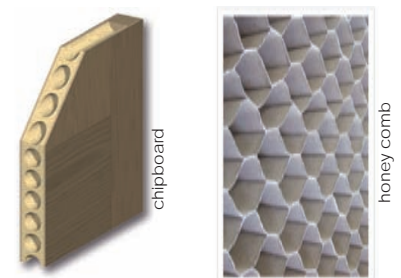

*not applicable for door leaves wrapped into bidirectional foil elm and teak.

STANDARD EQUIPMENT:

- lock 72 mm for standard key, WC knob or cylinder lock insert,
- screw-in pivot hinges – 2 pcs (3 pcs in door leaves “90” and “110”), white zinc.

Technical Approval ITB AT-15-6702/2005

Additional information on the equipment and accessories can be found at the page 50 - 51

ACCESSORIES AVAILABLE AT EXTRA CHARGE:

- chipboard filling
- ventilation undercut
- additional hinge in door widths from “60” to “80”
- non-rebated door for sliding system
- double door
- PVC ventilation sleeves
- cylinder lock insert 31/36
- door without a key hole
- door width „100”, „110”
- caps for hinges

AVAILABLE DOOR FRAMES:



BLOCK DOOR FRAME:

This is a door frame, which traditional simple design has been adapted to the typical thickness of the wall. With finishing trims, aesthetic performance and a wide range of decorative foils and natural veneers, it is a modern element of any interior equipment.



ADJUSTABLE DOOR FRAME:

This is a box type frame, which advantages are the possibility to cover each thickness of the wall and additional regulation. With modern design, aesthetic performance and a wide range natural veneers and decorative foils, it is a modern element of any interior equipment.

Detailed information on door frames can be found at the page 48 - 49

Aquarius · Libra · Taurus · Sagittarius



Aquarius 1

Aquarius 1

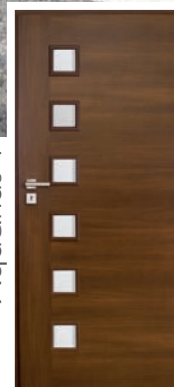

Aquarius 2



*NOTE: Door leaf TAURUS is available in bidirectional foil only

Libra



Taurus*



Sagittarius 1



Sagittarius 2



Sagittarius 3



AVAILABLE DECORS:



AVAILABLE GLASSES:

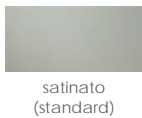

NOTE: the glossy side of glass is on the hinges side.

CONSTRUCTION OF FOILED DOORS AQUARIUS, LIBRA, TAURUS AND SAGITTARIUS:

- frame is made of MDF board,
- filling – „honey comb” or chipboard (optionally),
- frame with filling is covered with HDF boards on both sides,
- door leaf is wrapped into decorative foil (ENDURO/ECO-VENEER),
- frame for glass is in the door leaf color,
- side edges and upper edge are foiled,
- rounded side edges and upper edge,
- door leaf can be shortened by max 50 mm (not applicable to door leaves with ventilation),
- width of single doors – „60”, „70”, „80”, „90”, „100”*, „110”*,
- width of double doors – from „120” to „200”.*

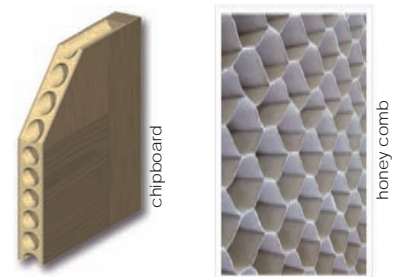

*not applicable for door leaves wrapped into bidirectional foil elm and teak.

STANDARD EQUIPMENT:

- lock 72 mm for standard key, WC knob or cylinder lock insert,
- screw-in pivot hinges – 2 pcs (3 pcs in door leaves “90” and “110”), white zinc.

Technical Approval ITB AT-15-6702/2005

Additional information on the equipment and accessories can be found at the page **50 - 51**

ACCESSORIES AVAILABLE AT EXTRA CHARGE:

- chipboard filling
- ventilation undercut
- additional hinge in door widths from “60” to “80”
- non-rebated door for sliding system
- double door
- PVC ventilation sleeves
- cylinder lock insert 31/36
- door without a key hole
- door width „100”, „110”
- caps for hinges

AVAILABLE DOOR FRAMES:



BLOCK DOOR FRAME:

This is a door frame, which traditional simple design has been adapted to the typical thickness of the wall. With finishing trims, aesthetic performance and a wide range of decorative foils and natural veneers, it is a modern element of any interior equipment.



ADJUSTABLE DOOR FRAME:

This is a box type frame, which advantages are the possibility to cover each thickness of the wall and additional regulation. With modern design, aesthetic performance and a wide range natural veneers and decorative foils, it is a modern element of any interior equipment.

Detailed information on door frames can be found at the page **48 - 49**

Torino · Merano



Torino 6

Torino 1



Torino 2



Torino 3



Torino 4



Torino 5



Torino 6



Merano 1



Merano 2



Merano 3



Merano 4



Merano 5



AVAILABLE DECORS:

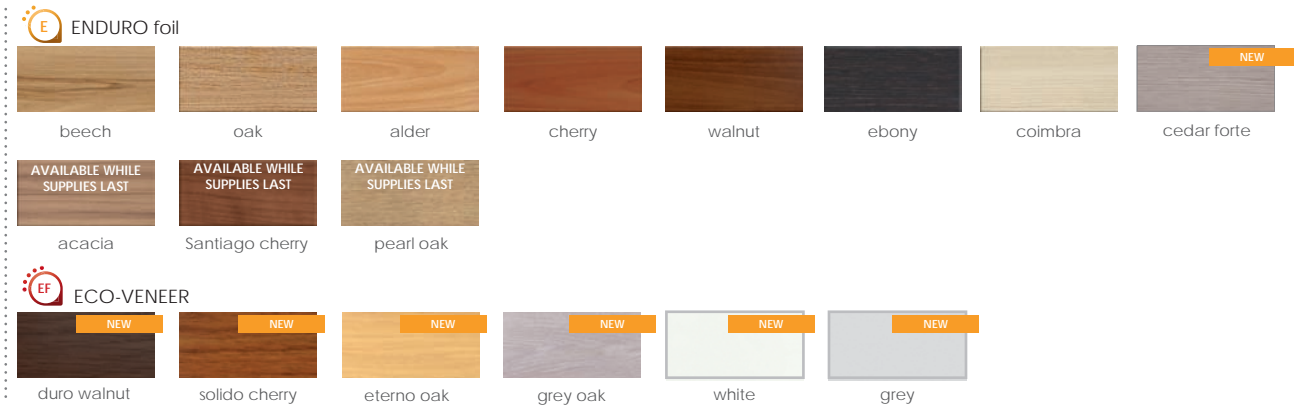

AVAILABLE GLASSES:

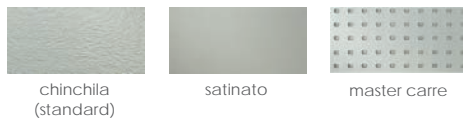

GLASS AVAILABLE AT EXTRA CHARGE:

master carre
satinato

NOTE : the glossy side of glass is on the hinges side.

CONSTRUCTION OF FOILED DOORS TORINO AND MERANO:

- frame is made of MDF board,
- filling – „honey comb” or chipboard (optionally),
- frame with filling is covered with HDF boards on both sides,
- door leaf is wrapped into decorative foil (ENDURO/ECO-VENEER),
- frame for glass is in the door leaf color,
- side edges and upper edge are foiled,
- rounded side edges and upper edge,
- door leaf can be shortened by max 50 mm (not applicable to door leaves with ventilation),
- width of single doors - from „60” to „110”,
- width of double doors – from „120” to „200”.

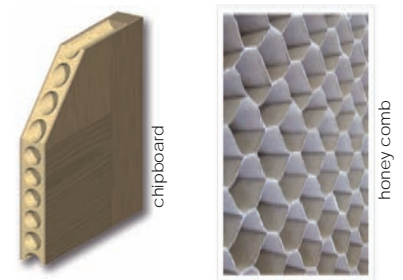

STANDARD EQUIPMENT:

- lock 72 mm for standard key, WC knob or cylinder lock insert,
- screw-in pivot hinges – 2 pcs (3 pcs in door leaves „90” and „110”), white zinc.

Technical Approval ITB AT-15-6702/2005

Additional information on the equipment and accessories can be found at the page **50 - 51**

ACCESSORIES AVAILABLE AT EXTRA CHARGE:

chipboard filling
ventilation undercut
additional hinge in door widths from “60” to “80”
non-rebated door for sliding system
double door
PVC ventilation sleeves
cylinder lock insert 31/36
door without a key hole
door width „100”, „110”
caps for hinges

AVAILABLE DOOR FRAMES:



BLOCK DOOR FRAME:

This is a door frame, which traditional simple design has been adapted to the typical thickness of the wall. With finishing trims, aesthetic performance and a wide range of decorative foils and natural veneers, it is a modern element of any interior equipment.



ADJUSTABLE DOOR FRAME:

This is a box type frame, which advantages are the possibility to cover each thickness of the wall and additional regulation. With modern design, aesthetic performance and a wide range natural veneers and decorative foils, it is a modern element of any interior equipment.

Detailed information on door frames can be found at the page **48 - 49**

Perugia · Modena · Verona



Perugia 1

Perugia 1



Perugia 2

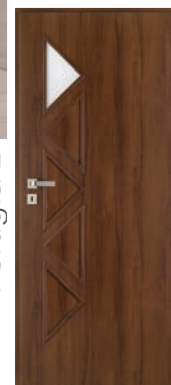

Perugia 3



Modena 1



Modena 2



Modena 3



Verona 1



Verona 2



AVAILABLE DECORS:

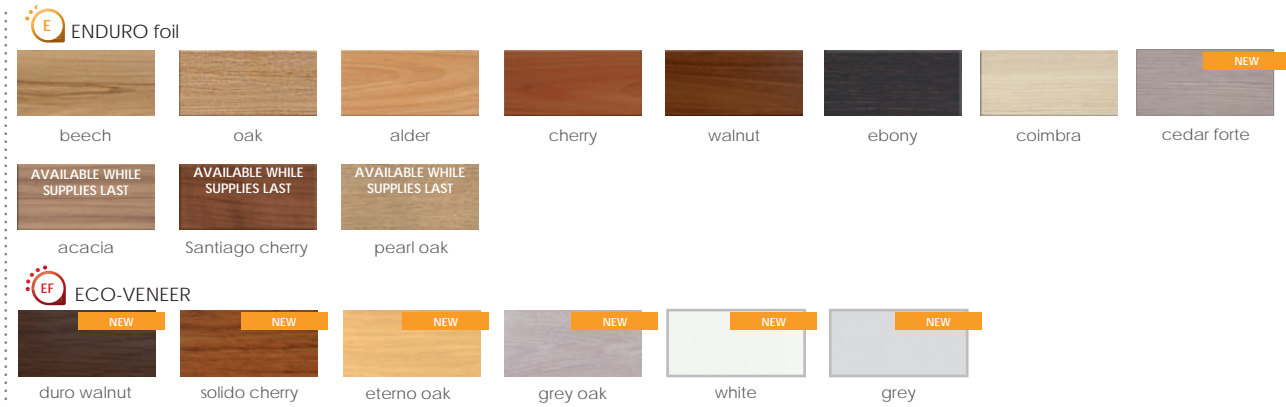

AVAILABLE GLASSES:

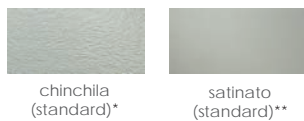

GLASS AVAILABLE AT EXTRA CHARGE:

satinato

NOTE: the glossy side of glass is on the hinges side.
 *Standard in Modena i Verona
 **Standard in Perugia

CONSTRUCTION OF FOILED DOORS PERUGIA, MODENA AND VERONA:

- frame is made of MDF board,
- filling – „honey comb” or chipboard (optionally),
- frame with filling is covered with HDF boards on both sides,
- door leaf is wrapped into decorative foil (ENDURO/ECO-VENEER),
- frame for glass is in the door leaf color,
- side edges and upper edge are foiled,
- rounded side edges and upper edge,
- door leaf can be shortened by max 50 mm (not applicable to door leaves with ventilation),
- width of single doors - from „60” to „110”,
- width of double doors – from „120” to „200”.

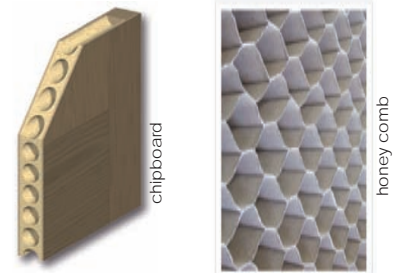

STANDARD EQUIPMENT

- lock 72 mm for standard key, WC knob or cylinder lock insert,
- screw-in pivot hinges – 2 pcs (3 pcs in door leaves „90” and „110”), white zinc.

Technical Approval ITB AT-15-6702/2005

Additional information on the equipment and accessories can be found at the page **50 - 51**

ACCESSORIES AVAILABLE AT EXTRA CHARGE:

- chipboard filling
- ventilation undercut
- additional hinge in door widths from “60” to “80”
- non-rebated door for sliding system
- double door
- PVC ventilation sleeves
- cylinder lock insert 31/36
- door without a key hole
- door width „100”, „110”
- caps for hinges

AVAILABLE DOOR FRAMES:



BLOCK DOOR FRAME:

This is a door frame, which traditional simple design has been adapted to the typical thickness of the wall. With finishing trims, aesthetic performance and a wide range of decorative foils and natural veneers, it is a modern element of any interior equipment.



ADJUSTABLE DOOR FRAME:

This is a box type frame, which advantages are the possibility to cover each thickness of the wall and additional regulation. With modern design, aesthetic performance and a wide range natural veneers and decorative foils, it is a modern element of any interior equipment.

Detailed information on door frames can be found at the page **48 - 49**

Dolce · Nida · Classic



Dolce 2



Dolce 1

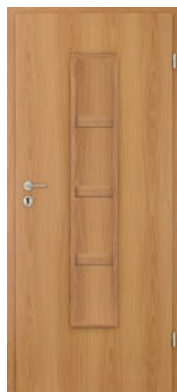

Dolce 2



Dolce 3



Nida 1



Nida 2



Nida 3



Classic 1

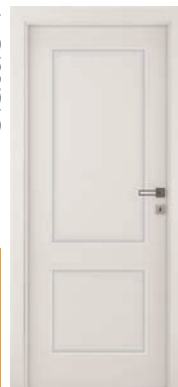

NEW

Classic 2

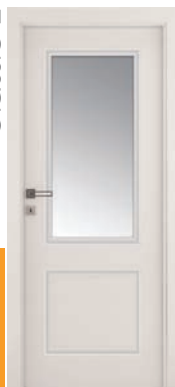

NEW

AVAILABLE DECORS:

E ENDURO foil

beech	oak	alder	cherry	walnut	ebony	coimbra	cedar forte

NEW

lindo*

AVAILABLE WHILE SUPPLIES LAST

acacia

AVAILABLE WHILE SUPPLIES LAST

Santiago cherry

AVAILABLE WHILE SUPPLIES LAST

pearl oak

EF ECO-VENEER

duro walnut	solido cherry	eterno oak	grey oak	white	grey

**Decors „acacia”, „ebony” and „cedar forte” are not available in case of ND2 and ND3.
*Decor „lindo” is available ONLY in case of CLASSIC collection.**

AVAILABLE GLASSES:

chinchilla (standard)*	satinato (standard)**

NOTE : the glossy side of glass is on the hinges side.
*Standard in Norma Decor **Standard in Dolce

CONSTRUCTION OF FOILED DOORS DOLCE, NIDA AND NORMA DECOR:

- frame is made of MDF board,
- filling – „honey comb” or chipboard (optionally),
- frame with filling is covered with HDF boards on both sides,
- door leaf is wrapped into decorative foil (ENDURO/ECO-VENEER),
- frame for glass is in the door leaf color,
- side edges and upper edge are foiled,
- rounded side edges and upper edge,
- door leaf can be shortened by max 50 mm (not applicable to door leaves with ventilation),
- width of single doors - from „60” to „110”,
- width of double doors – from „120” to „200”.

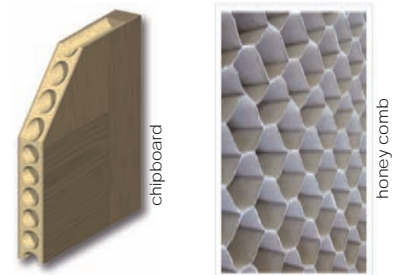

STANDARD EQUIPMENT:

- lock 72 mm for standard key, WC knob or cylinder lock insert,
- screw-in pivot hinges – 2 pcs (3 pcs in door leaves “90” and “110”), white zinc.

Technical Approval ITB AT-15-6702/2005

Additional information on the equipment and accessories can be found at the page **50 - 51**

ACCESSORIES AVAILABLE AT EXTRA CHARGE:

- chipboard filling
- ventilation undercut
- ventilation grid (NORMA DECOR only)
- additional hinge in door widths from “60” to “80”
- non-rebated door for sliding system
- double door
- PVC ventilation sleeves
- cylinder lock insert 31/36
- door without a key hole
- door width „100”, „110”
- caps for hinges

AVAILABLE DOOR FRAMES:



BLOCK DOOR FRAME:

This is a door frame, which traditional simple design has been adapted to the typical thickness of the wall. With finishing trims, aesthetic performance and a wide range of decorative foils and natural veneers, it is a modern element of any interior equipment.



ADJUSTABLE DOOR FRAME:

This is a box type frame, which advantages are the possibility to cover each thickness of the wall and additional regulation. With modern design, aesthetic performance and a wide range natural veneers and decorative foils, it is a modern element of any interior equipment.

Detailed information on door frames can be found at the page **48 - 49**

Norma Decor



Norma Decor 1

Norma Decor 1



Norma Decor 2



Norma Decor 3



Norma Decor 4



Norma Decor 5



NEW
Norma Decor 6

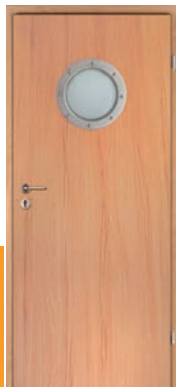

There is a possibility to produce NORMA DECOR 1 in reinforced version - detailed information can be found at the page 42 

AVAILABLE DECORS:

E ENDURO foil

beech	oak	alder	cherry	walnut	ebony	coimbra	cedar forte

NEW lindo

AVAILABLE WHILE SUPPLIES LAST: acacia, Santiago cherry, pearl oak

EF ECO-VENEER

duro walnut	solido cherry	eterno oak	grey oak	white	grey

Decor „acacia”, „ebony” and „cedar forte” are not available in case of ND2 and ND3.

AVAILABLE GLASSES:

chinchilla (standard)*	satinato (standard)**

NOTE : the glossy side of glass is on the hinges side.
 *Standard in Norma Decor **Standard in Dolce

CONSTRUCTION OF FOILED DOORS NORMA DECOR:

- frame is made of MDF board,
- filling – „honey comb” or chipboard (optionally),
- frame with filling is covered with HDF boards on both sides,
- door leaf is wrapped into decorative foil (ENDURO/ECO-VENEER),
- frame for glass is in the door leaf color,
- side edges and upper edge are foiled,
- rounded side edges and upper edge,
- door leaf can be shortened by max 50 mm (not applicable to door leaves with ventilation),
- width of single doors - from „60” to „110”,
- width of double doors – from „120” to „200”.

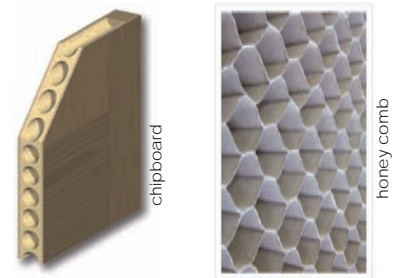

STANDARD EQUIPMENT:

- lock 72 mm for standard key, WC knob or cylinder lock insert,
- screw-in pivot hinges – 2 pcs (3 pcs in door leaves “90” and “110”), white zinc.

Technical Approval ITB AT-15-6702/2005

Additional information on the equipment and accessories can be found at the page **50 - 51**

ACCESSORIES AVAILABLE AT EXTRA CHARGE:

- chipboard filling
- ventilation undercut
- ventilation grid
- additional hinge in door widths from “60” to “80”
- non-rebated door for sliding system
- double door
- PVC ventilation sleeves
- cylinder lock insert 31/36
- door without a key hole
- door width „100”, „110”
- caps for hinges

AVAILABLE DOOR FRAMES:



BLOCK DOOR FRAME:

This is a door frame, which traditional simple design has been adapted to the typical thickness of the wall. With finishing trims, aesthetic performance and a wide range of decorative foils and natural veneers, it is a modern element of any interior equipment.



ADJUSTABLE DOOR FRAME:

This is a box type frame, which advantages are the possibility to cover each thickness of the wall and additional regulation. With modern design, aesthetic performance and a wide range natural veneers and decorative foils, it is a modern element of any interior equipment.

Detailed information on door frames can be found at the page **48 - 49**

Amber



Amber 12



overprint on transparent glass
Amber 1



overprint on transparent glass
Amber 2



overprint on transparent glass
Amber 3



overprint on satinato glass
Amber 4



overprint on transparent glass
Amber 5



overprint on transparent glass
Amber 6



overprint on transparent glass
Amber 7



overprint on satinato glass
Amber 8



engraving on satinato glass
Amber 9



overprint on satinato glass
Amber 10



overprint on transparent glass
Amber 11



engraving on satinato glass
Amber 12



satinato glass
Amber 13



transparent glass
Amber 14

CONSTRUCTION OF GLASS DOORS AMBER:

- GLASS : tempered, 8 mm-thick,
- door leaf width : „60“, „70“, „80“, „90“,
- block or adjustable door frame, 2 hinges
- glass pane should be ordered together with door frame,
- the matt side of glass is on the hinges side.

DIMENSIONS OF GLASS DOORS (MM)	„60“	„70“	„80“	„90“
door leaf width	617	717	817	917
door leaf height	2027	2027	2027	2027

ACCESSORIES FOR GLASS DOORS:

NEW

lock V6000 INX - simple



HANDLE V6000 INX - simple or rounded:

VERSION 1: handle + lock without a hole + hinges + caps

VERSION 2: handle + cylinder lock + hinges + caps

VERSION 3: handle + lock WC + hinges + caps

NEW

lock V6000 INX - rounded



HANDLE METALGLASS

VERSION 1: handle + lock without a hole + hinges + caps

VERSION 2: handle + cylinder lock + hinges + caps

VERSION 3: handle + lock WC + hinges + caps

lock METALGLAS V -100 with handle ASTORIA



HANDLE INVADO

VERSION 1: handle + lock without a hole + hinges + caps

VERSION 2: handle + cylinder lock + hinges + caps

VERSION 3: handle + lock WC + hinges + caps

lock with handle INVADO



hinge METALGLAS v -100



Handles INVADO and METALGLASS available in color nickel.
Handles V6000 INX available in color stainless steel.

AVAILABLE DOOR FRAMES:



BLOCK DOOR FRAME:

This is a door frame, which traditional simple design has been adapted to the typical thickness of the wall. With finishing trims, aesthetic performance and a wide range of decorative foils and natural veneers, it is a modern element of any interior equipment.



ADJUSTABLE DOOR FRAME:

This is a box type frame, which advantages are the possibility to cover each thickness of the wall and additional regulation. With modern design, aesthetic performance and a wide range natural veneers and decorative foils, it is a modern element of any interior equipment.

Detailed information on door frames can be found at the page 48 - 49

Plano · Quadro

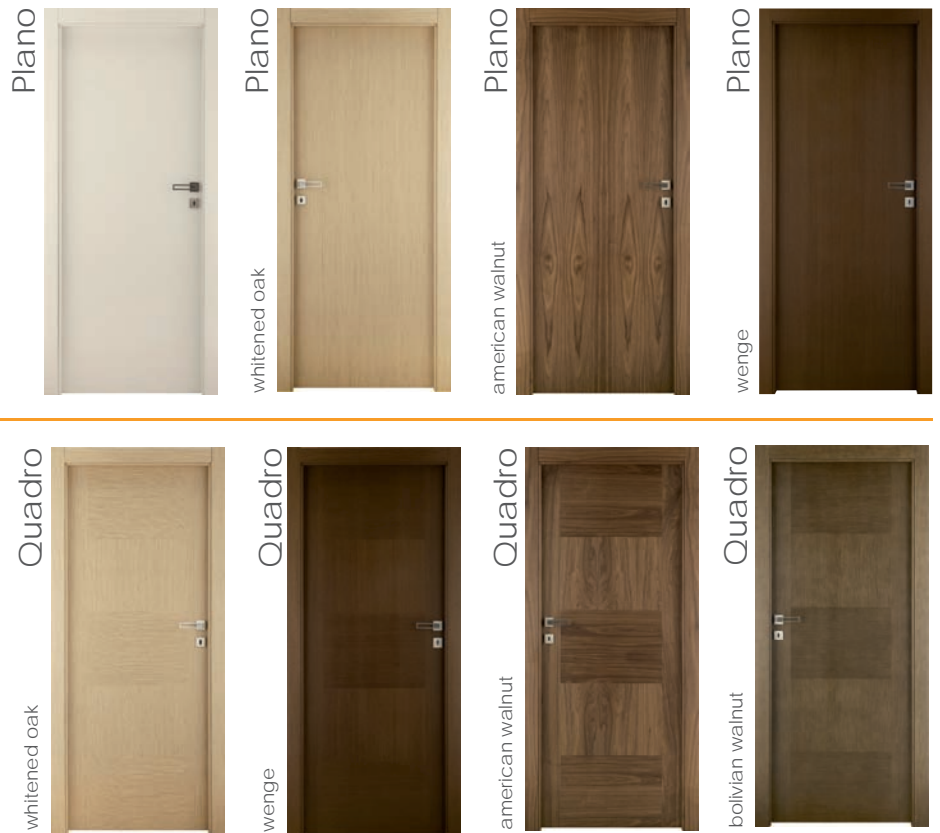

AVAILABLE DECORS:



CONSTRUCTION AND STANDARD EQUIPMENT OF NON-REBATED DOORS PLANO AND QUADRO:

- rama z drewna klejonego sosnowego,
- chipboard filling,
- frame with filling is covered with HDF boards on both sides,
- possibility to shorten (cut) the door leaf by 40 mm,
- flat edge (without rebate),
- magnetic lock*,
- 2 invisible hinges, regulation 3D, INOX color,
- door leaf is wrapped into veneer and lacquered**,
- porthole (at extra charge).

* in buildings with heavy traffic it is recommended to use a standard lock.
 **with the exception of PLANO without visible graining

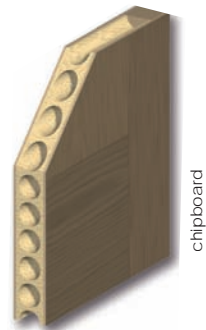

Technical Approval ITB AT-15-6702/2005

AVAILABLE DOOR FRAMES:



ADJUSTABLE DOOR FRAME FOR NON-REBATED DOORS:

The door frame is designed for non-rebated doors. Architraves in the door frame are joined at right angle. Available in veneered version only.

Detailed information on door frames can be found at the page 48 - 49

Egida



E ENDURO foil

- beech
- walnut
- ebony
- Santiago cherry (AVAILABLE WHILE SUPPLIES LAST)
- pearl oak (AVAILABLE WHILE SUPPLIES LAST)
- chestnut

EF ECO-VENEER

- duro walnut (NEW)
- solido cherry (NEW)
- eterno oak (NEW)
- grey oak (NEW)
- white (NEW)
- grey (NEW)

CONSTRUCTION OF INTERIOR ENTRANCE DOORS:

- frame is made of finger-joint pinewood, filled with chipboard
- block door frame 90x44 mm made of finger-joint pinewood covered with MDF board or metal frame,
- fixed threshold made of finger-joint pinewood,
- metal frame in RAL colors: brown 8017, honey 8003, white 9010, beige 1001.

STANDARD EQUIPMENT:

- multipoint strip lock ,
- 3 reinforced hinges ,
- acoustic insulation $R_w = 29 \text{ dB}^*$,
- break-in resistance class 2,

*acoustic insulation class $R_w = 27 \text{ dB}$

ACCESSORIES AVAILABLE AT EXTRA CHARGE:

- Handle/rosette JANE, M3 - brown grafiatto, M6/M9 chrome/nickel, L/R
- set of cylinder lock inserts (insert + insert with a knob), break-in resistance class 2, 30 x 40 mm, 6 keys
- panoramic viewfinder
- automatic door bottom seal for doors to 90 cm width
- automatic door bottom seal for doors to 100-110 cm width

Additional information on the equipment and accessories can be found at the page 50 - 51

RECOMMENDED DIMENSIONS OF WALL OPENING FOR DOOR FRAME :

	metal door frame					wooden door frame				
door leaf width	„70”	„80”	„90”	„100”	„110”	„70”	„80”	„90”	„100”	„110”
width of wall opening	790	890	990	1090	1190	818	918	1018	1118	1218
height of wall opening	2070	2070	2070	2070	2070	2084	2084	2084	2084	2084

NORMA DECOR 7- REINFORCED



- DECORS:** All decors available for NORMA DECOR 1
- ACCESSORIES AT EXTRA CHARGE :** the same as for EGIDA
- STANDARD EQUIPMENT :** 2 independent locks, 3 hinges
- DOOR CONSTRUCTION :**
- double frame made of MDF board, filled with chipboard
 - block door frame 90 mm x 44 mm made of MDF board or metal one
 - metal frame in RAL colors: brown 8017, honey 8003, white 9010, beige 1001
 - door leaf width: „80” - „110”

Guardia

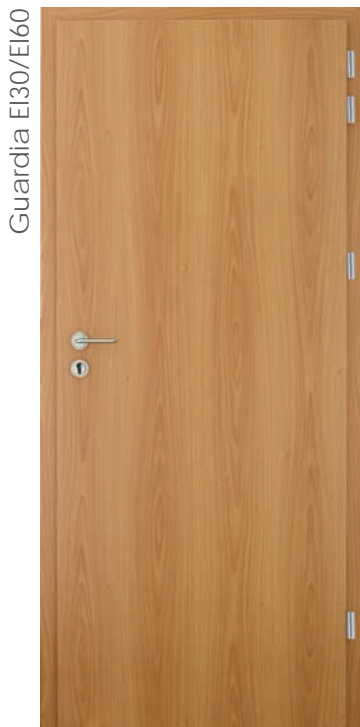

Guardia EI30/EI60

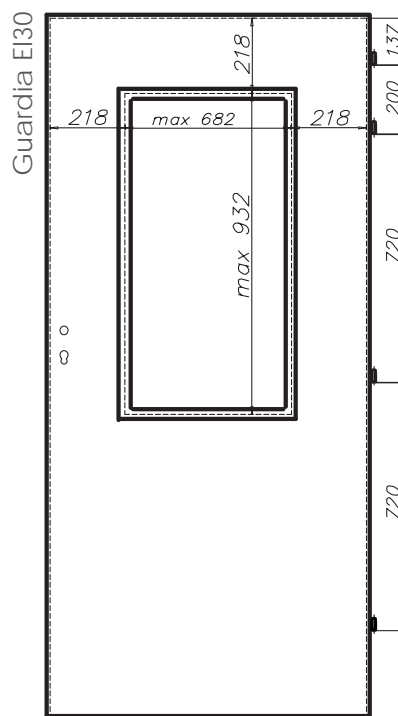

Door leaf thickness
EI30 = 56 mm

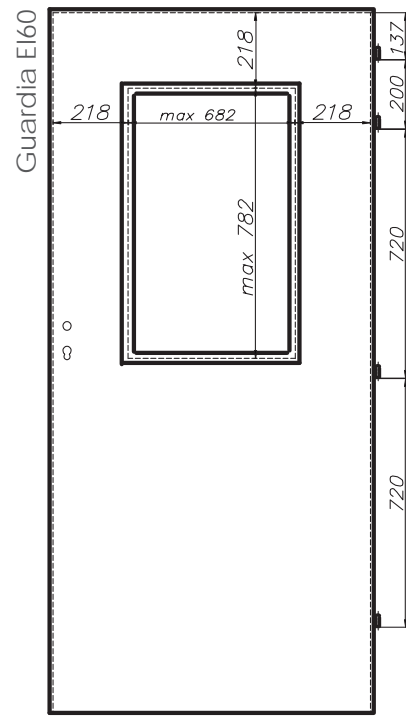

Door leaf thickness
EI60 = 66 mm

Acoustic insulation index for
GUARDIA EI30 :

- fixed threshold - RW = 34 dB *
- automatic door bottom seal - RW = 33 dB*

Fire resistance EI30 (30 min).

*** acoustic insulation class of 32 dB**

Acoustic insulation index for
GUARDIA EI60 :

- fixed threshold - RW = 34 dB *
- automatic door bottom seal - RW = 33 dB*

Fire resistance EI60 (60 min).

*** acoustic insulation class of 32 dB**

APPLICATION:

Fire doors GUARDIA EI30 and GUARDIA EI60 are designed for hotels, catering facilities, banks, offices and other public and residential buildings, where the fire resistance is required to be maintained.

GUARDIA doors have Technical Approval **AT-15-8020/2009** and certificate of compliance **ITB-2017 / W**.

In order to comply with technical approval, the self-closing device has to be used for GUARDIA EI30 and EI60 doors, according to the standard **EN-14 600** (in case of double door the closing sequence regulator must also be applied) and the cylinder lock insert meeting the requirements of INVADO technical approval.

GUARDIA doors can be sold only with door frames.

REFERENCE OBJECT: HOTEL „CASTLE” IN LUBLINIEC – EXAMPLE OF GUARDIA DOORS APPLICATION:

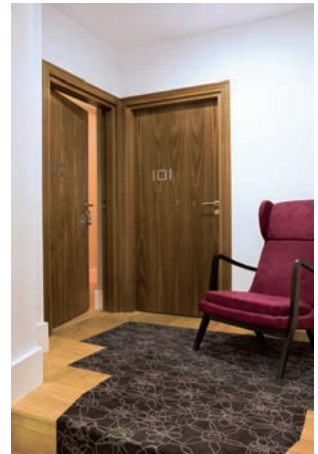
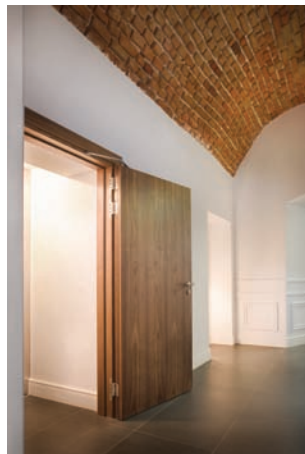

AVAILABLE DECORS:



STANDARD EQUIPMENT:

- fire resistant chipboard, covered with HDF and cork boards on both sides,
- decorative foil ENDURO or ECO-veneer,
- cylinder lock ,
- intumescent seals,
- MDF block frame 100x60 mm,
- automatic door bottom seal,
- 4 hinges with regulation 3,
- in case of glazed doors – fire resistant glass,
- GUARDIA doors can be sold only with door frames.

ADDITIONAL EQUIPMENT:

- set* of mounting screws with expansion sleeves in sizes 10/152 for brick walls,
- set* of self - drilling screws, size 6.54 x 95 for palstER board walls

*the set includes 8 screws

NOTE: for GUARDIA doors with automatic door bottom seal, the fixed threshold is not applicable.

ACCESSORIES AVAILABLE AT EXTRA CHARGE:

self-closer
viewfinder
smoke protection
covering profile (trim)
quadrant LC1
architrave
enlarging element 100 mm
enlarging element 200 mm
enlarging element 300 mm
mounting kit for plasterboard walls
mounting kit for brick walls

GUARDIA TECHNICAL DOOR DIMENSIONS (mm)	single door					double door						
	„70”	„80”	„90”	„100”	„110*”	„140”	„150”	„160”	„170”	„180”	„190”	„200”
width of door leaf	744	844	944	1044	1144	1479	1579	1679	1779	1879	1979	2079
width of wall opening	852	952	1052	1152	1252	1587	1687	1787	1887	1987	2087	2187
outer width of door frame	822	922	1022	1122	1222	1557	1657	1757	1857	1957	2057	2157
internal width of door frame	702	802	902	1002	1102	1437	1537	1637	1737	1837	1937	2037
height of door leaf	2040	2040	2040	2040	2040	2040	2040	2040	2040	2040	2040	2040
height of wall opening	2100	2100	2100	2100	2100	2100	2100	2100	2100	2100	2100	2100
outer height of door frame	2085	2085	2085	2085	2085	2085	2085	2085	2085	2085	2085	2085
internal height of door frame	2025	2025	2025	2025	2025	2025	2025	2025	2025	2025	2025	2025

*unavailable in elm and teak.

Ignis

NEW



ENDURO foil					
beech	oak	alder	cherry	walnut	ebony
coimbra	cedar forte	lindo	acacia	Santiago cherry	pearl oak
ECO-VENEER					
duro walnut	solido cherry	eterno oak	grey oak	white	grey

CONSTRUCTION OF IGNIS DOORS:

- frame is made of laminated pinewood,
- filling : mineral wool with density of 120kg/m³,
- frame and filling is covered with 3 mm-thick HDF board,
- single door leaves in wooden frame - widths from „60” to „100”,
- single door leaves in metal frame - widths from „60” to „110”.

APPLICATION:

IGNIS EI 30 fire doors are full doors (no glass), rebated, single, fire resistance EI30 in case of MDF or metal frame. The door with MDF frame can be mounted in walls made of ceramic or silica bricks, min. thickness 100 mm, concrete or reinforced concrete bricks with min. thickness 100 mm, cellular concrete blocks with min. thickness 100 mm and min. density of 650 kg/m³.

The door with metal door frame can be mounted in walls made of ceramic or silica bricks, min. thickness 115 mm, concrete or reinforced concrete bricks with min. thickness 100 mm, cellular concrete blocks with min. thickness 115 mm and min. density of 650 kg/m³.

In order to comply with technical approval, the self-closing device has to be used for IGNIS doors, according to the standard **EN-14 600** and the cylinder lock insert meeting the requirements of INVADO technical approval.

IGNIS door has Technical Approval No. **AT-15-8750/2011** and certificate of conformity No. **W134**.

STANDARD EQUIPMENT:

- set of intumescent seals,
- latch-bolt lock,
- 3 screw-in pivot hinges,

ACCESSORIES AVAILABLE AT EXTRA CHARGE:

- metal door frame
- automatic door bottom seal for door width up to “90”
- cylinder lock insert meeting the requirements of INVADO technical approval.

NOTE: for IGNIS doors with automatic door bottom seal, the fixed threshold is not applicable.

NEW

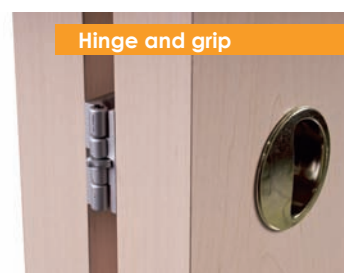

Hinge and grip



Rail

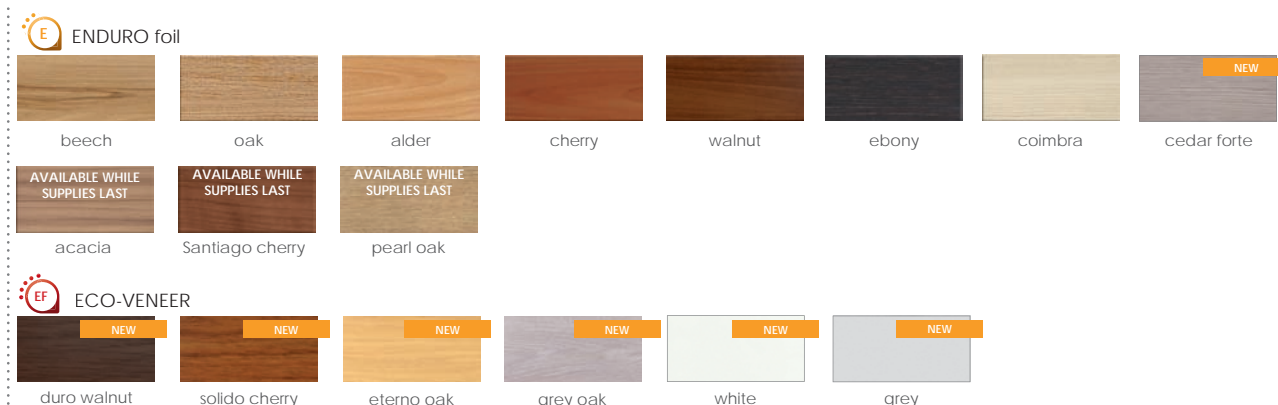

CONSTRUCTION OF FOLDING DOORS:

- folding door consists of folded door leaf and wall casing based on block door frame,
- the frame of each half of folded door leaf is made of MDF board or laminated semi-finished pinewood, 33 mm-thick,
- filling - „honey comb”
- door leaf and filling are covered with 3 mm-thick MDF boards,
- each half of door leaf has a rabbet along the vertical edge on the door frame vertical element side,
- both halves of door leaf are joined together by spring hinges, allowing for the maintenance of their mutual parallelism when closed,
- the door leaf is connected to the floor with a spigot fixed in the holder, which is bolted to the floor,
- the upper part is connected to the door frame with a spigot fixed in the holder, which is mounted in the rail bolted to the upper element of door frame,
- the sliding mechanism (trolley), mounted in the rail, stabilizes the door leaf when opening and closing. The door leaf is equipped with two grips,
- widths of folding door - from „60” to „90”.

AVAILABLE DOOR FRAMES:



BLOCK DOOR FRAME:

This is a door frame, which traditional simple design has been adapted to the typical thickness of the wall. With finishing trims, aesthetic performance and a wide range of decorative foils and natural veneers, it is a modern element of any interior equipment.

ON-WALL SLIDING SYSTEM



The set includes :

- rail
- -rail cover in the door leaf color
- round grip, chrome or satin color

Options at extra charge:

- Adjustable frame with fender beam (wall casing) ORS3,
- Key hook lock (chrome, satin, golden),
- WC hook lock (chrome, satin, golden).

Extra charge for hook lock includes :

- hook lock
- striking plate (for assembly)
- "broken" key or WC knob
- set of grips
- thimble – 1 piece
-

TYPES OF ON-WALL SLIDING SYSTEM:

- single door system
- double door system

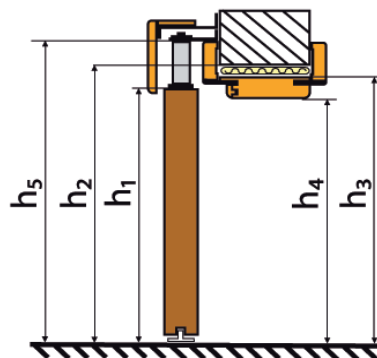
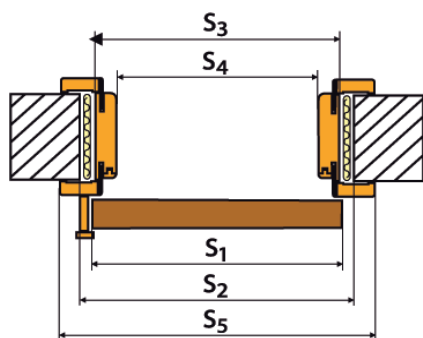

DIMENSIONS OF DOOR LEAF AND DOOR FRAME FOR ON-WALL SLIDING SYSTEM (mm)

		door frame for single door				door frame for double door			
door leaf		„60”	„70”	„80”	„90”	„120”	„140”	„160”	„180”
s_1	width of door leaf	618	718	818	918	618+618	718+718	818+818	918+918
s_2	width of wall opening*	640	740	840	940	1258	1458	1658	1858
s_3	outer width of door frame	610	710	810	910	1228	1428	1628	1828
s_4	internal width of door frame	566	666	766	866	1184	1384	1584	1784
s_5	width of door frame with trims	710	810	910	1010	1328	1528	1728	1928
h_1	height of door leaf	2027	2027	2027	2027	2027	2027	2027	2027
h_2	height of wall opening	2054	2054	2054	2054	2054	2054	2054	2054
h_3	outer height of door frame	2039	2039	2039	2039	2039	2039	2039	2039
h_4	internal height of door frame*	2017	2017	2017	2017	2017	2017	2017	2017
h_5	height of door frame with trims	2089	2089	2089	2089	2089	2089	2089	2089

*Dimensions of wall opening for the version without door frame should be identical to the internal width of the door frame

“POCKET” SLIDING SYSTEM (HIDDEN IN THE WALL)



Each model of INVADO doors can be used for the sliding system (with the exception of technical and glass doors)

Construction cassette „100“ is prepared for installation of selected door leaves only : NORMA DECOR, TAURUS and all veneered and modular doors).

Construction cassette „125“ is prepared for installation of all INVADO door leaves.

Accessories included in the price :

- construction cassette for sliding system „100“ or „125“
- set of profiles (door frame)
- set of covering profiles for both sides of the door frame
- brushes and gaskets
- grip (chrome , satin or golden)

DIAGRAM OF THE LOCATION OF DOOR FRAME ELEMENTS FOR SLIDING SYSTEM (plasterboard wall)

• single for plasterboard wall

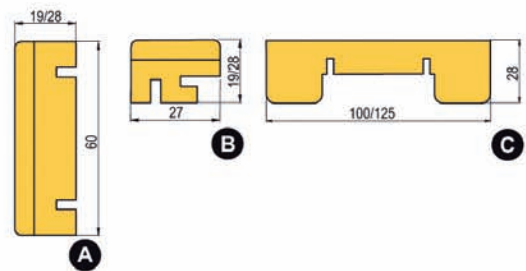
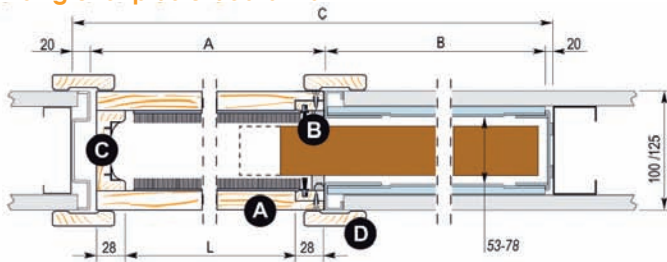

• double for plasterboard wall

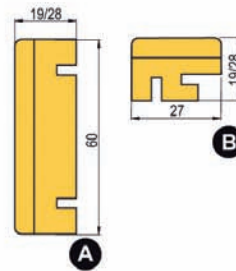
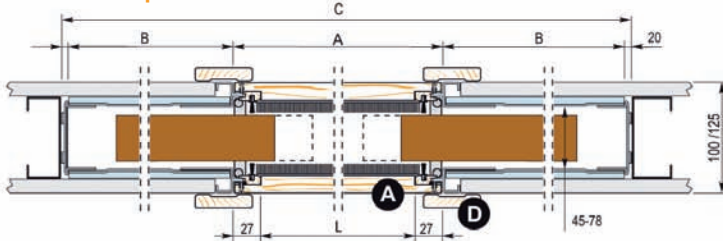

- A** upper profile
- B** vertical profile
- C** fender beam
- D** trim (covering profile)

Dimensions of cassette for single sliding system

DOOR LEAF DIMENSIONS

internal width L x H	outer width C x H1	A	B	wall thickness	width	height
600 x 1990	1305 x 2105	650	615	100-125	618	2027
700 x 1990	1505 x 2105	750	715	100-125	718	2027
800 x 1990	1705 x 2105	850	815	100-125	818	2027
900 x 1990	1905 x 2105	950	915	100-125	918	2027
1000 x 1990	2105 x 2105	1050	1015	100-125	1018	2027

Dimensions of cassette double sliding system

DOOR LEAF DIMENSIONS

internal width L x H	outer width C x H1	A	B	wall thickness	width	height
1180 X 1990	2520 x 2105	1250	615	100-125	618	2027
1380 X 1990	2920 x 2105	1450	715	100-125	718	2027
1580 X 1990	3320 x 2105	1650	815	100-125	818	2027
1780 X 1990	3720 x 2105	1850	915	100-125	918	2027
1980 X 1990	4120x 2105	2050	1015	100-125	1018	2027

H - internal width of door frame H1 - internal height of door frame

Door dimensions · Door frames



DIMENSIONS OF REBATED DOORS:

	„60”	„70”	„80”	„90”	„100”	„110”
A	618	718	818	918	1018	1118
B	644	744	844	944	1044	1144
C	2027	2027	2027	2027	2027	2027
D	2040	2040	2040	2040	2040	2040

NOTE: Dimensions A and C are outer dimensions of non-rebated doors and doors prepared for sliding systems.

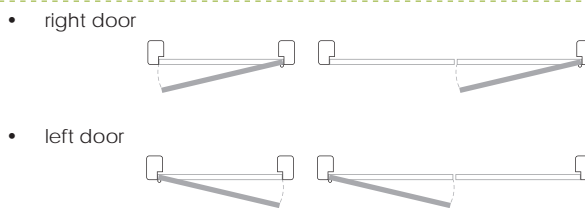

ADJUSTABLE DOOR FRAME FOR NON-REBATED DOORS:



FEATURES:

- MDF profiles are wrapped into natural veneer,
- architraves are joined at right angles,
- width of architrave – 80 mm.

Technical Approval ITB AT-15-5393/2008

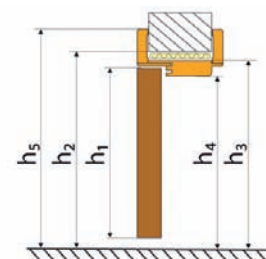
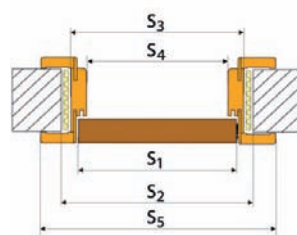

DIMENSIONS OF DOOR LEAF AND NON-REBATED DOOR FRAME

		single door					double door						
door leaf		„60”	„70”	„80”	„90”	„100”	„120”	„130”	„140”	„150”	„160”	„170”	„180”
s_1	width of door leaf	618	718	818	918	1018	1239	1339	1439	1539	1639	1739	1839
s_2	width of wall opening	696	796	896	996	1096	1316	1416	1516	1616	1716	1816	1916
s_3	outer width of door frame	666	766	866	966	1066	1286	1386	1486	1586	1686	1786	1886
s_4	internal width of door frame	600	700	800	900	1000	1220	1320	1420	1520	1620	1720	1820
s_5	width of door frame with trims	784	884	984	1084	1184	1404	1504	1604	1704	1804	1904	2004
h_1	height of door leaf	2027	2027	2027	2027	2027	2027	2027	2027	2027	2027	2027	2027
h_2	height of wall opening	2062	2062	2062	2062	2062	2062	2062	2062	2062	2062	2062	2062
h_3	outer height of door frame	2047	2047	2047	2047	2047	2047	2047	2047	2047	2047	2047	2047
h_4	internal height of door frame	2025	2025	2025	2025	2025	2025	2025	2025	2025	2025	2025	2025
h_5	height of door frame with trims	2117	2117	2117	2117	2117	2117	2117	2117	2117	2117	2117	2117

ADJUSTABLE DOOR FRAME:

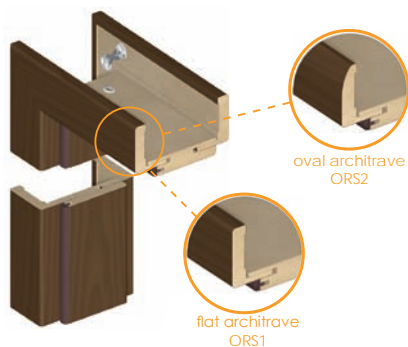

CONSTRUCTION:

- MDF board is wrapped into:
- foil naturalna (fornir) o grubości 0,3 mm,
 - foil sztuczna ENDURO lub ECO-VENEER.

Technical Approval ITB AT-15-5393/2008

DIMENSIONS:

- Adjustable door frame is made in dimensions adjustable to the wall thickness in steps of 20 mm. The minimum wall thickness is 75 mm. Door frame for the wall thickness greater than 340 mm consists of at least two connected components. Door frames are made for rebated doors in the following sizes:
- single doors - widths „60” - „110”,
 - double doors – widths „120” - „200”.

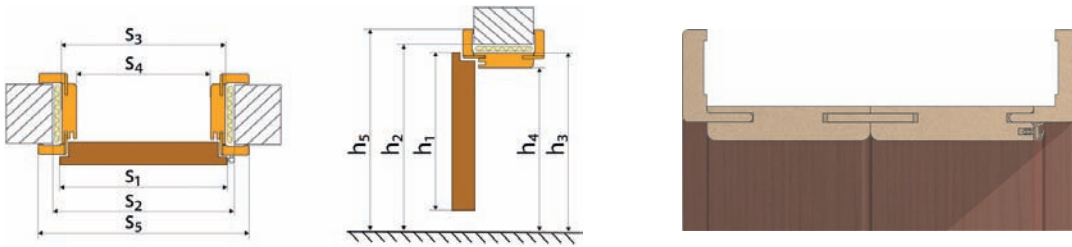

Door frame for the wall thickness greater than 340 mm consists of at least two connected components.

DIMENSIONS OF DOOR LEAF AND ADJUSTABLE DOOR FRAME (mm)

door leaf		drzwi single door						drzwi double door								
		„60”	„70”	„80”	„90”	„100”	„110”	„120”	„130”	„140”	„150”	„160”	„170”	„180”	„190”	„200”
s ₁	width of door leaf	644	744	844	944	1044	1144	1264	1364	1464	1564	1664	1764	1864	1964	2064
s ₂	width of wall opening	674	774	874	974	1074	1174	1294	1394	1494	1594	1694	1794	1894	1994	2094
s ₃	outer width of door frame	644	744	844	944	1044	1144	1264	1364	1464	1564	1664	1764	1864	1964	2064
s ₄	internal width of door frame	600	700	800	900	1000	1100	1220	1320	1420	1520	1620	1720	1820	1920	2020
s ₅	width of door frame with trims	744	844	944	1044	1144	1244	1364	1464	1564	1664	1764	1864	1964	2064	2164
h ₁	height of door leaf	2040	2040	2040	2040	2040	2040	2040	2040	2040	2040	2040	2040	2040	2040	2040
h ₂	height of wall opening	2062	2062	2062	2062	2062	2062	2062	2062	2062	2062	2062	2062	2062	2062	2062
h ₃	outer height of door frame	2047	2047	2047	2047	2047	2047	2047	2047	2047	2047	2047	2047	2047	2047	2047
h ₄	internal height of door frame	2025	2025	2025	2025	2025	2025	2025	2025	2025	2025	2025	2025	2025	2025	2025
h ₅	height of door frame with trims	2097	2097	2097	2097	2097	2097	2097	2097	2097	2097	2097	2097	2097	2097	2097

BLOCK DOOR FRAME:

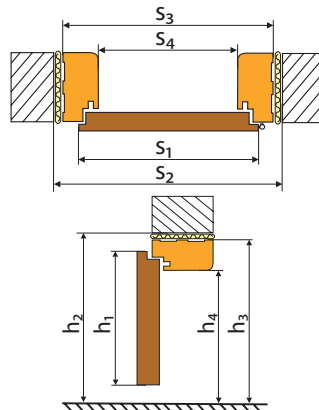
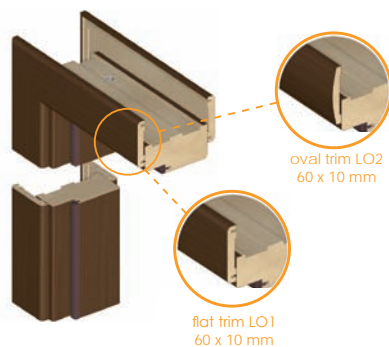

CONSTRUCTION:

MDF board is wrapped into :

- Natural veneer with a thickness of 0.3 mm,
- ENDURO decorative foil or ECO-veneer.

Technical Approval ITB AT-15-6597/2009

DIMENSIONS:

Cross-section: 90 x 44 mm. Door frames are made to the rebated door leaves in the following sizes:

- single doors - widths „60” - „110”,
- double doors - widths „120” - „200”.

DIMENSIONS OF DOOR LEAF AND BLOCK DOOR FRAME OB3 AND OB6

door leaf		single door						double door								
		„60”	„70”	„80”	„90”	„100”	„110”	„120”	„130”	„140”	„150”	„160”	„170”	„180”	„190”	„200”
s ₁	width of door leaf	644	744	844	944	1044	1144	1264	1364	1464	1564	1664	1764	1864	1964	2064
s ₂	width of wall opening	718	818	918	1018	1118	1218	1338	1438	1538	1638	1738	1838	1938	2038	2138
s ₃	outer width of door frame	688	788	888	988	1088	1188	1308	1408	1508	1608	1708	1808	1908	2008	2108
s ₄	internal width of door frame	600	700	800	900	1000	1100	1220	1320	1420	1520	1620	1720	1820	1920	2020
h ₁	height of door leaf	2040	2040	2040	2040	2040	2040	2040	2040	2040	2040	2040	2040	2040	2040	2040
h ₂	height of wall opening	2084	2084	2084	2084	2084	2084	2084	2084	2084	2084	2084	2084	2084	2084	2084
h ₃	outer height of door frame	2069	2069	2069	2069	2069	2069	2069	2069	2069	2069	2069	2069	2069	2069	2069
h ₄	internal height of door frame	2025	2025	2025	2025	2025	2025	2025	2025	2025	2025	2025	2025	2025	2025	2025

ACCESSORIES/OPTIONS FOR ADJUSTABLE AND BLOCK DOOR FRAMES FOR AN EXTRA CHARGE

door frames with transoms up to 5 l.m.-circuit (no glazing)

door frames for double doors

adjustable door frame with oval covering profiles (trims)

non-typical dimensions

wall framing („blind door frame”)

additional hinge in door frame „60” - „80”

adjustable door frame for single on-wall sliding system (flat covering profile only, type ORS 3)

ACCESSORIES

ACCESSORIES FOR INTERIOR DOORS:



hinge with 3D regulation



caps for hinges



invisible hinge with 3D regulation (non-rebated doors)



magnetic lock (non-rebated doors)



porthole (Quadro, Plano, Norma Decor 6)



ventilation grid (Norma Decor)



ventilation undercut



ventilation square sleeves



ventilation round sleeves

Technical information about ventilation.

According to the norm, the door to the bathroom, shower and separate WC should open outwards, have the passage width of at least 0.8 m and height of 2 m, and have the ventilation holes for the air supply in the bottom of the door with total ventilation area of at least 0.022 m². The total ventilation area is the sum of the gap under the door (standard 7mm) and additional solutions that increase the total net ventilation area of such as: ventilation sleeves, ventilation undercut and ventilation grid. The use of ventilation grid ensures the correct ventilation area for all door widths, while using the sleeve and / or undercut the increased gap between the door and the floor should be used in order to meet the required regulations. If the above mentioned regulations must be obliged the clients must trim the door on their own.

Door width	Number of ventilation sleeves	door leaf with ventilation sleeves*		door leaf with ventilation undercut*		door leaf with ventilation grid*	
		Total ventilation area: ventilation sleeves and the gap under the door (7 mm) m ²	Required gap under the door to fulfill the legal regulations (mm)	Total ventilation area: ventilation undercut and the gap under the door (7 mm) m ²	Required gap under the door to fulfill the legal regulations (mm)	Total ventilation area: ventilation grid and the gap under the door (7 mm) m ²	Required gap under the door to fulfill the legal regulations (mm)
,60"	3**	0,0060	34	0,0042	25	> 0,022	--
,70"	4	0,0074	28	0,0060	23	> 0,022	--
,80"	5**	0,0087	24	0,0078	22	> 0,022	--
,90"	6	0,0100	21	0,0096	20	> 0,022	--
,100"	6	0,0107	19	0,0114	18	> 0,022	--
,110"	6	0,0114	17	0,0132	16	> 0,022	--

*door collections where the ventilation sleeves, ventilation undercut and ventilation grid cannot be used: D'artagnan collection. In collection Richelieu there is a possibility to install ventilation sleeves.

** in model Richelieu 2, by door width ,60" there are 4 pcs. of ventilation sleeves, by door width ,80" there are 6 ventilation sleeves.

Sliding doors fulfill the ventilation requirements due to the construction of the system. In doors INVADO there is no possibility to use simultaneously more solutions for ventilation.



PLANO - laquer + porthole

ACCESSORIES FOR **SLIDING DOORS:**



profiles and architraves
(for system „in the wall”)



gasket (for system „in the wall”)



brush (for system „in the wall”)



rail cover
(for system „on the wall”)

ACCESSORIES FOR **INTERIOR AND EXTERIOR ENTRANCE DOORS:**



cylinder lock insert with a knob



handle + rosette
JANE (EGIDA)



handle + rosette STRATOS
(SECURO)



panoramic viewfinder

ACCESSORIES FOR **TECHNICAL DOORS:**



viewfinder



self-closer



automatic door bottom seal



HANDLE **INVADO**

Available colors:

- M6/M9 chrome/nickel

Available lock types:

- Key/cylinder lock insert
- WC



HANDLE **PRESTO**

Available colors:

- M6/M9 chrome/nickel

Available lock types:

- Key/cylinder lock insert
- WC



HANDLE **LAVIA**

Available colors:

- M6/M9 chrome/nickel

Available lock types:

- Key/cylinder lock insert
- WC



HANDLE **GIUSSY**

Available colors:

- M3 brown grafiatto
- M6/M9 chrome/nickel

Available lock types:

- Key/cylinder lock insert
- WC



HANDLE **PRADO**

Available colors:

- INX - stainless steel

Available lock types:

- Key/cylinder lock insert
- WC



HANDLE **NERIS**

Available colors:

- M3 brown grafiatto
- M9 nickel

Available lock types:

- Key/cylinder lock insert
- WC

Due to the construction the handle NERIS cannot be used in doors ATOS, PORTOS, ARAMIS



HANDLE **INVADO-QR**

Available colors:

- M9 nickel

Available lock types:

- Key/cylinder lock insert
- WC



HANDLE **QUBIK**

Available colors:

- M9 nickel

Available lock types:

- Key/cylinder lock insert
- WC



HANDLE **LIZBONA**

Available colors:

- M3 brown grafiatto
- M4 satinated chrome
- M9 nickel

Available lock types:

- Key/cylinder lock insert
- WC



HANDLE **TINA**

Available colors:

- M1 lacquered brass
- M3 brown grafiatto
- M4 satinated chrome
- M6 chrome
- M9 nickel
- SN satinated nickel

Available lock types:

- Key/cylinder lock insert
- WC



HANDLE **NET**

Available colors:

- M6 chrome
- M9 nickel

Available lock types:

- Key/cylinder lock insert
- WC



HANDLE **OMEGA**

Available colors:

- M6/M9 chrome/nickel

Available lock types:

- Key/cylinder lock insert
- WC

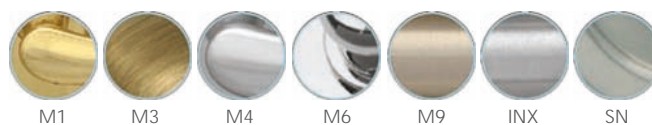

Prestige

Skirtings Prestige are higher than traditional wooden profiles and provide the floor with a frame effect which gives more nobility to the interior. INVADO Prestige collection is targeted at the more demanding customers and designers. Parquet skirting boards are made of MDF board and prepared for self-painting or finished with veneer/foil.

ACCESSORIES::

- white corner, dimensions 22x22x120 mm
- clip – 30 pcs.

P 124

DIMENSIONS:
15 x 100 mm



P 125

DIMENSIONS:
15 x 60 mm



P 129

DIMENSIONS:
15 x 80 mm



P 127

DIMENSIONS:
15 x 110 mm



P 132

DIMENSIONS:
15 x 100 mm

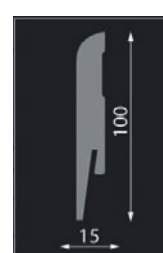

P 130

DIMENSIONS:
15 x 100 mm



Length of the skirting: 2,40 m. Skirtings packed 5 pcs. in box.

skirting	Foil white, paintable.	finish foil ENDURO	EMBOSSSED foil	ECO-VENEER	NATURAL veneer	MODIFIED veneer
P 124	✓	✓	✓	✓	X	X
P 125	✓	X	X	X	X	X
P 127	✓	X	X	X	X	X
P 129	✓	✓	✓	✓	✓	✓
P 130	✓	X	X	X	X	X
P 132	✓	X	X	X	✓	✓

CHINCHILA



CHINCHILA BROWN



SATINATO

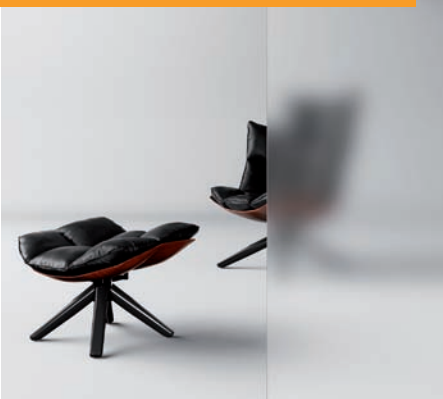

MASTER CARRE



BEVELLED CRYSTAL TRANSPARENT



BEVELLED CRYSTAL FROSTED



BEVELLED CRYSTAL BROWN



Glass applications INVADO compose perfectly with doors D'Artagnan, Domino, Modena, Gwinea, Amber and Bianco. An additional advantage is easy installation. It is enough to stick them in the selected position on the special double-sided glue tape (included). Due to the melted glass technology and colour differentiation of the glass panels we get unique applications which pattern is never perfectly reproducible.

DIMENSIONS: 90 x 90 mm .





All information in the catalogue do not constitute an offer within the meaning of the Civil Code and are published for informational purposes only. This catalogue is valid from 02/01/2012. Manufacturer reserves the right to make changes. Note! Due to the printing technique the colors of the products presented in the catalogue may differ from the original. All rights reserved. Copying and publication of this catalogue on web sites and in other media without the written consent from INVADO Sp. z o.o. is prohibited.

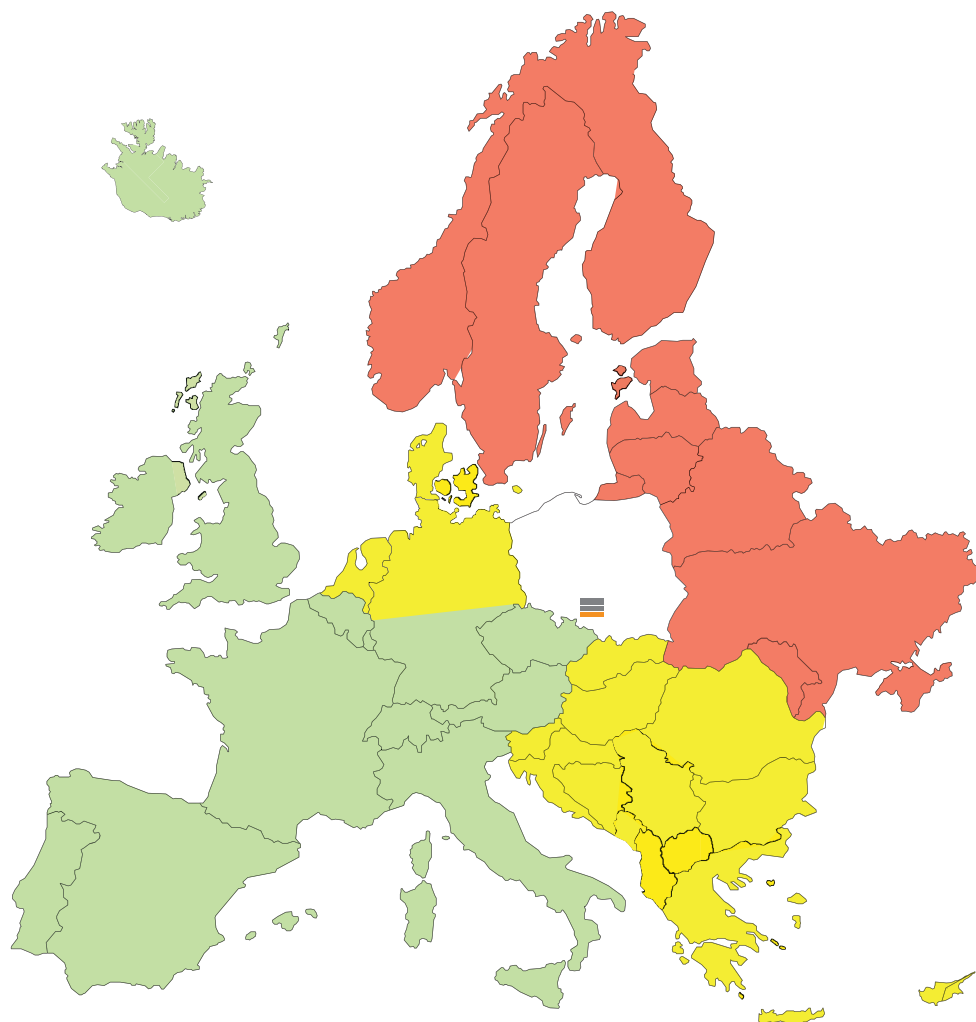

EXPORT DEPARTMENT:

Tel. +48 35 10 550
Mob. +48 508 052 407
Fax. +48 34 353 56 02

Tel. +48 35 13 878
Mob. +48 508 052 406
Fax. +48 34 353 56 02

Tel. +48 35 10 549
Mob. +48 509 680 283
Fax. +48 34 353 56 02

Tel. +48 35 10 882
Mob. +48 513 120 072
Fax. +48 34 353 56 02

INVADO Sp. z o.o.
Dzielna, ul. Leśna 2
42-793 Ciasna
Polska

e-mail: biuro@invado.pl

tel. +48 34 351 05 40
fax +48 34 353 56 02

www.invado.pl

facebook

JOIN US ON:
www.facebook.com/INVADO



QR CODE